



HOTEL





An aerial night photograph of a modern city, likely Dubai, featuring a canal, a bridge, and several illuminated skyscrapers. The scene is vibrant with city lights and reflections on the water.

ÍNDICE

Casa de banho <i>Bathroom</i>	4
Quarto <i>Bedroom</i>	38
Zonas comuns <i>Common areas</i>	46
Zonas tecnicas <i>Technical aids</i>	94





ESTRENEMOS...

RELEASE...

Colecciones de

BAÑO

Bathroom Collections

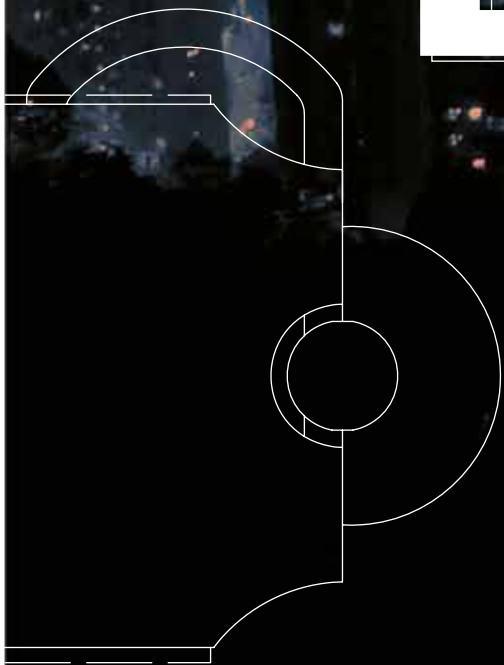

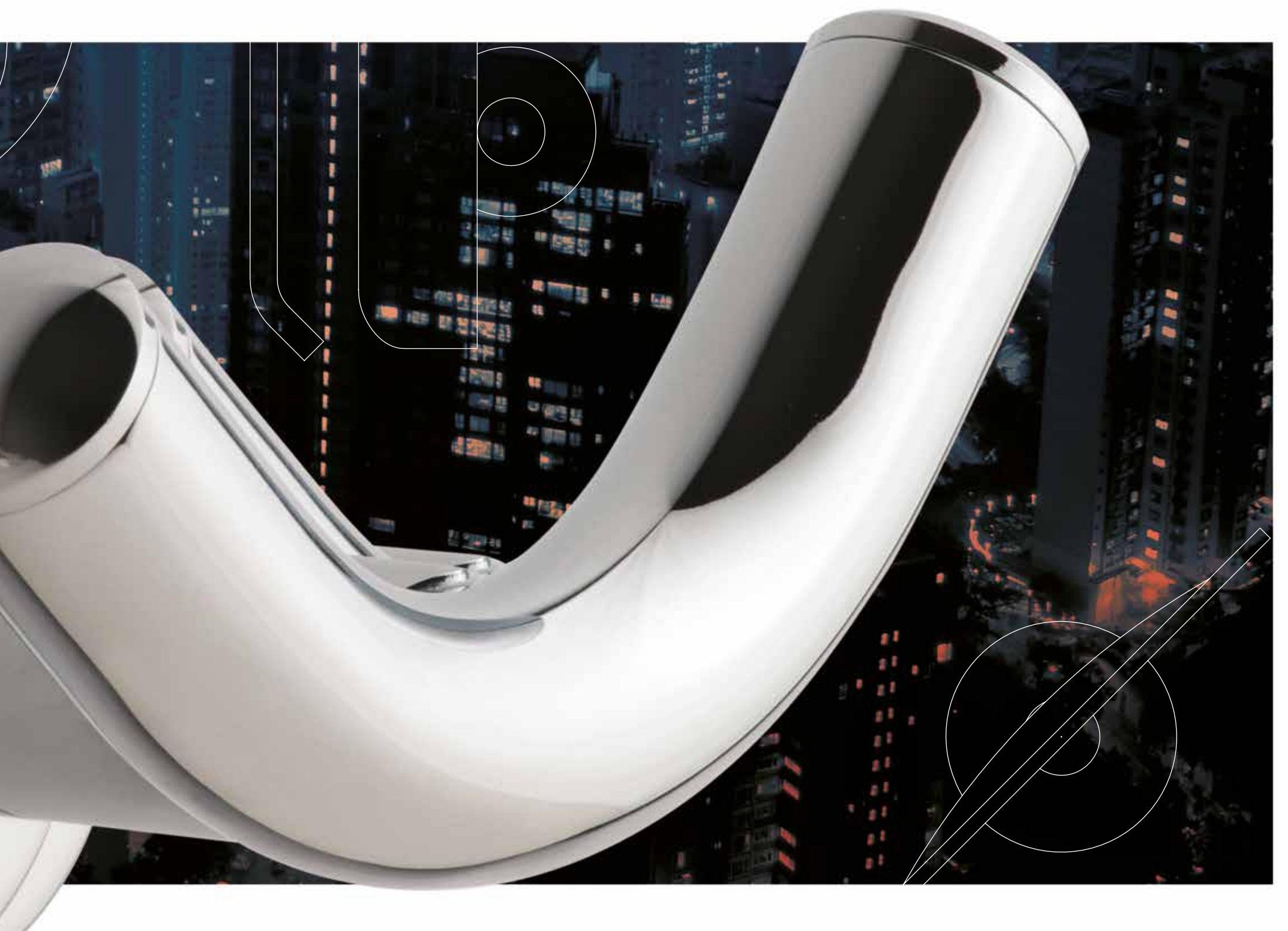

MILÃO

Material Latón cromado *Material Chromed brass*
Acabado BRILLO *POLISH finished (.B)*

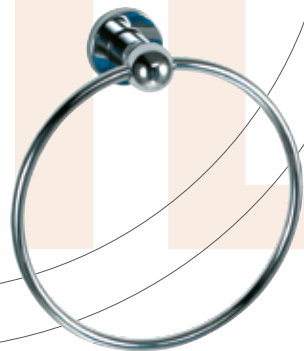

16357.B

Aro toallero grande
Large hoop for towels
Dimensiones *Dimensions*
219 x 200 x 65 mm



16352.B

Barra recta, tubo Ø 25 mm. Doble uso (asidero / toallero)
Straight bar, tube bar 25 mm. Double use (Hand-bar / towel holder)
Dimensiones *Dimensions*
50 x 300 x 105 mm



16351.B

Barra recta Tubo Ø 20 mm
Straight bar Tube bar 20 mm
Dimensiones *Dimensions*
50 x 520 x 105 mm



16354.B

Asidero angular, tubo Ø 25 mm. Sin jabonera
Angled support handle, tube bar 25 mm. Without soap dish
Dimensiones *Dimensions*
195 x 400 x 120 mm

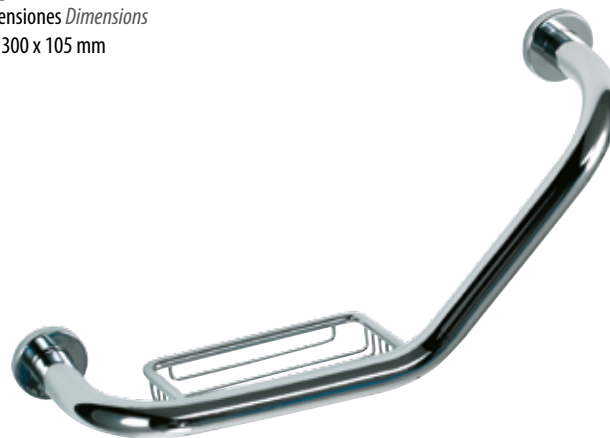

16355.B

Asidero angular, tubo Ø 25 mm. Con jabonera
Angled support handle, tube bar 25 mm. With soap dish
Dimensiones *Dimensions*
195 x 400 x 120 mm



16362.B

Jabonera
Soap dish
Dimensiones *Dimensions*
48 x 120 x 131 mm



16356.B

Vaso para cepillos de dientes con soporte a pared
Glass for toothbrush with wall support
 Dimensiones *Dimensions*
 50 x 72 x 111 mm



16361.B

Portarrollos de papel higiénico
Toilet paper dispenser
 Dimensiones *Dimensions*
 102 x 128 x 160 mm

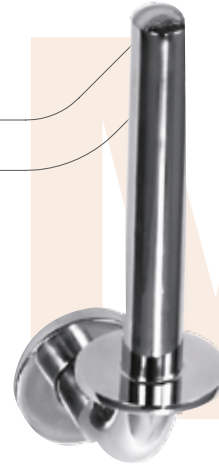

16350.B

Portarrollos reserva
Toilet paper reserve
 Dimensiones *Dimensions*
 208 x 50 x 100 mm



16359.B

Percha
Hook
 Dimensiones *Dimensions*
 80 x 50 x 75 mm



16363.B

Percha
Hook
 Dimensiones *Dimensions*
 30 x 30 x 40 mm



16360.B

Percha doble
Double hook
 Dimensiones *Dimensions*
 67 x 117 x 72 mm



09060.B 09060.S

Escobillero con soporte a pared
Toilet brush with wall support
 Dimensiones *Dimensions*
 410 mm. Ø 90 mm

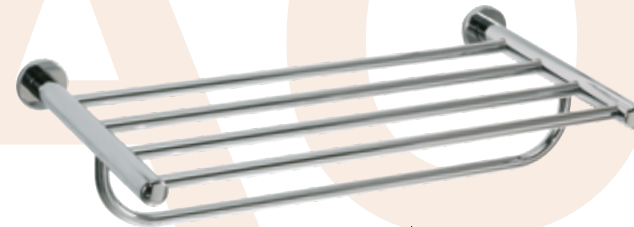

16358.B

Repisa toallero con barra inferior
Towel shelf with lower bar
 Dimensiones *Dimensions*
 125 x 520 x 307 mm

MONACO

Material Latón cromado *Material Chromed brass*
Acabado BRILLO POLISH *finished (.B)*



16377.B

Aro toallero
Hoop for towels
Dimensiones *Dimensions*
205 x 180 x 45 mm



16371.B

Barra recta
Towel rail
Dimensiones *Dimensions*
54 x 654 x 67 mm Tubo *Tube* Ø 16 mm

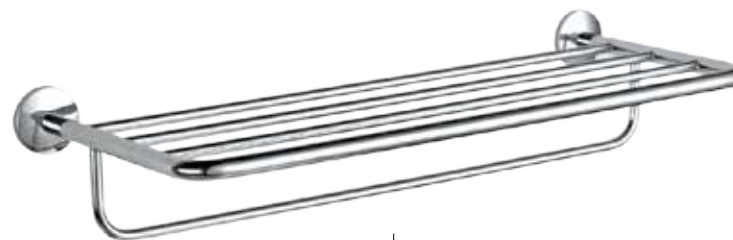

16378.B

Repisa toallero con barra inferior
Towel shelf with lower bar
Dimensiones *Dimensions*
110 x 550 x 230 mm



16372.B

Jabonera de vidrio con soporte mural
Glass soap dish with wall support
Dimensiones *Dimensions*
55 x 110 x 125 mm

16376.B

Vaso para cepillos de dientes con soporte a pared
Glass for toothbrush with wall support
Dimensiones *Dimensions*
95 x 70 x 105 mm



Material Latón cromado *Material Chromed brass*
Acabado BRILLO *POLISH finished (.B)*

MONACO



16374.B

Portarrollos de papel higiénico
Toilet paper dispenser
Dimensiones *Dimensions*
150 x 165 x 135 mm



16381.B

Portarrollos reserva
Toilet paper reserve
Dimensiones *Dimensions*
175 x 54 x 64 mm



16379.B

Percha
Hook
Dimensiones *Dimensions*
67 x 54 x 64 mm



16370.B

Percha doble
Double hook
Dimensiones *Dimensions*
54 x 62 x 40 mm



16373.B

Percha doble
Double hook
Dimensiones *Dimensions*
60 x 100 x 57 mm



09060.B 09060.S

Escobillero con soporte a pared
Toilet brush with wall support
Dimensiones *Dimensions*
410 mm. Ø 90 mm

BARCELONA

Material Acero inoxidable AISI 304 *Material AISI 304 Stainless Steel*
Acabado BRILLO POLISH finished (.B)

Consultar disponibilidad *Consult availability*

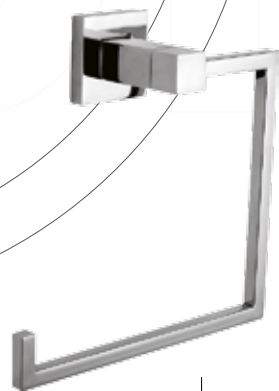

16905.B

Aro toallero
Hoop for towels
Dimensiones *Dimensions*
180 x 184 x 70 mm

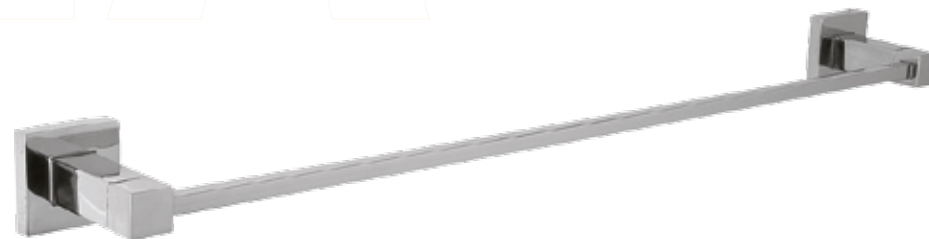

16901.B

Barra recta
Towel rail
Dimensiones *Dimensions*
50 x 630 x 80 mm

16902.B

Toallero doble
Double towel rail
Dimensiones *Dimensions*
50 x 630 x 140 mm

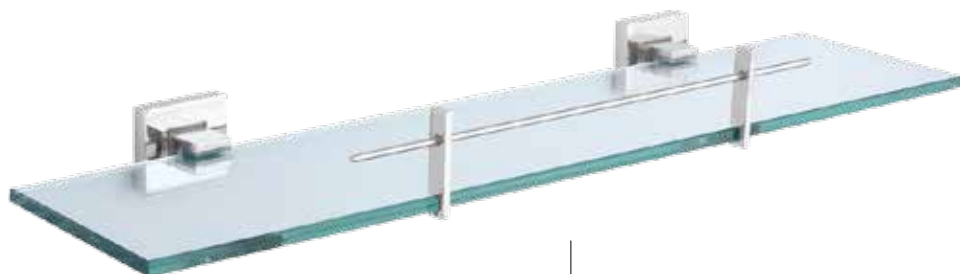

16910.B

Repisa de vidrio
Glass utility shelf
Dimensiones *Dimensions*
64 x 530 x 155 mm



16906.B

Percha
Hook
Dimensiones *Dimensions*
60 x 50 x 70 mm



16907.B

Percha doble
Double hook
Dimensiones *Dimensions*
50 x 90 x 70 mm

Material Acero inoxidable AISI 304 *Material AISI 304 Stainless Steel*
Acabado BRILLO *POLISH finished (.B)*

Consultar disponibilidad *Consult availability*

BARCELONA



16900.B

Portarrollos reserva
Toilet paper reserve
Dimensiones *Dimensions*
50 x 162 x 85 mm



16912.B

Jabonera
Soap dish
Dimensiones *Dimensions*
55 x 125 x 112 mm



16913.B

Vaso para cepillos de dientes con soporte a pared
Glass for toothbrush with wall support
Dimensiones *Dimensions*
95 x 115 x 98 mm



16915.B

Escobillero
Toilet brush
Dimensiones *Dimensions*
310 x 155 x 122 mm

FLORENÇA

Material Acero inoxidable AISI 304 *Material AISI 304 Stainless steel*
Acabado SATINADO *SATIN finished (.S)*



16860.S

Aro toallero
Towel hoop
Dimensiones *Dimensions*
190 x 170 x 50 mm



16856.S

Repisa de vidrio
Glass utility shelf
Dimensiones *Dimensions*
55 x 600 x 128 mm



16850.S

Toallero. Tubo Ø 20 mm
Towel rail. Tube Ø 20 mm
Dimensiones *Dimensions*
55 x 655 x 65 mm



16855.S

Jabonera
Soap dish
Dimensiones *Dimensions*
55 x 125 x 112 mm



16851.S

Percha
Hook
Dimensiones *Dimensions*
55 x 55 x 50 mm



16852.S

Doble percha
Double hook
Dimensiones *Dimensions*
55 x 55 x 60 mm

Material Acero inoxidable AISI 304 *Material AISI 304 Stainless steel*
Acabado SATINADO *SATIN finished (.S)*

FLORENÇA



16858.S

Portarrollos de papel higiénico
Toilet paper dispenser
Dimensiones *Dimensions*
133 x 138 x 65 mm

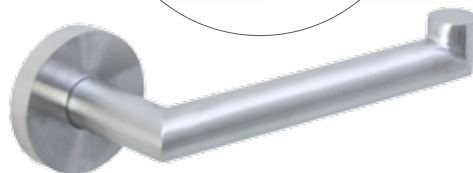

16859.S

Portarrollos reserva
Toilet paper reserve
Dimensiones *Dimensions*
55 x 178 x 65 mm



16861.S

Vaso para cepillos de dientes con soporte a pared
Glass for toothbrush with wall support
Dimensiones *Dimensions*
100 x 68 x 105 mm



16857.S

Escobillero
Toilet brush
Dimensiones *Dimensions*
310 x 115 x 142 mm



16853.S

Repisa toallero con barra inferior
Towel shelf with lower bar
Dimensiones *Dimensions*
108 x 655 x 221 mm

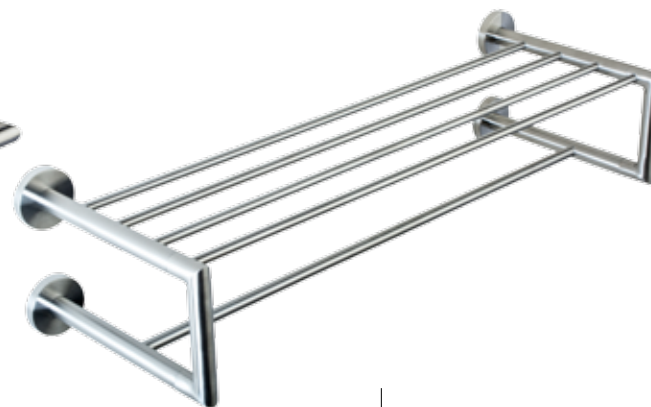

16854.S

Repisa toallero con barra inferior
Towel shelf with lower bar
Dimensiones *Dimensions*
156 x 655 x 221 mm

FLORENÇA

Material Acero inoxidable AISI 304 / Material AISI 304 Stainless steel
Acabado BRILLO POLISH finished (.B)



16860.B

Aro toallero
Towel hoop
Dimensiones Dimensions
190 x 170 x 50 mm

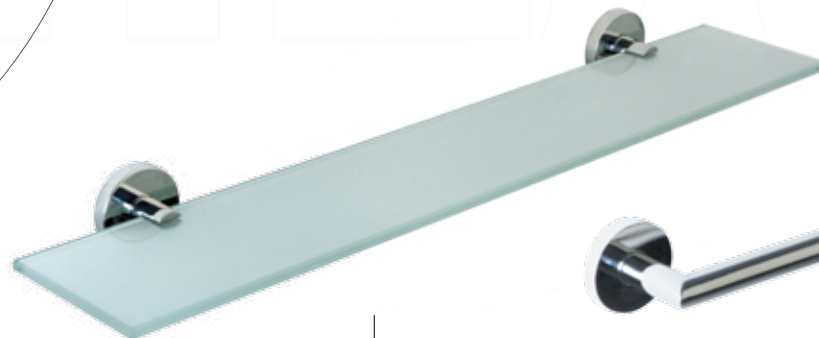

16856.B

Repisa de vidrio
Glass utility shelf
Dimensiones Dimensions
55 x 600 x 128 mm

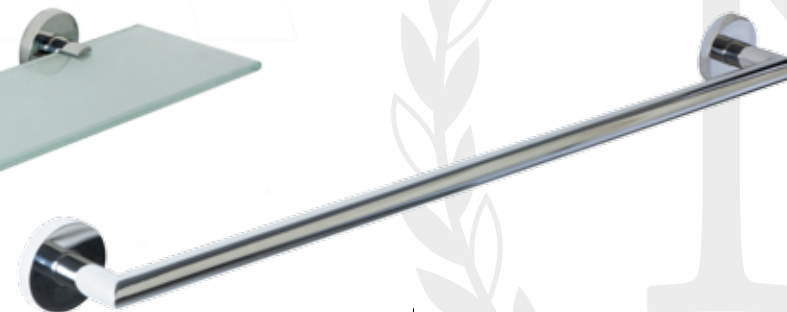

16850.B

Toallero. Tubo Ø 20 mm
Towel rail. Tube Ø 20 mm
Dimensiones Dimensions
55 x 655 x 65 mm



16855.B

Jabonera
Soap dish
Dimensiones Dimensions
55 x 125 x 112 mm



16851.B

Percha
Hook
Dimensiones Dimensions
55 x 55 x 50 mm



16852.B

Doble percha
Double hook
Dimensiones Dimensions
55 x 55 x 60 mm

Material Acero inoxidable AISI 304 *Material AISI 304 Stainless steel*
Acabado BRILLO *POLISH finished (.B)*

FLORENÇA



16858.B

Portarrollos de papel higiénico
Toilet paper dispenser
Dimensiones *Dimensions*
133 x 138 x 65 mm



16859.B

Portarrollos reserva
Toilet paper reserve
Dimensiones *Dimensions*
55 x 178 x 65 mm



16861.B

Vaso para cepillos de dientes con soporte a pared
Glass for toothbrush with wall support
Dimensiones *Dimensions*
100 x 68 x 105 mm



16857.B

Escobillero
Toilet brush
Dimensiones *Dimensions*
310 x 115 x 142 mm



16853.B

Repisa toallero con barra inferior
Towel shelf with lower bar
Dimensiones *Dimensions*
108 x 655 x 221 mm



16854.B

Repisa toallero con barra inferior
Towel shelf with lower bar
Dimensiones *Dimensions*
156 x 655 x 221 mm

PÁDUA

Material Zamac *Material Zamac*
Acabado BRILLO POLISH finished (.B)



16504.B

Aro toallero *Towel hoop*
Dimensiones *Dimensions*
185 x 150 x 65 mm

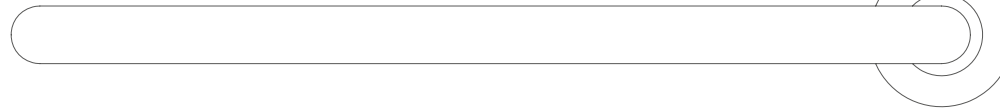

16515.B

Repisa de vidrio *Glass utility shelf*
Dimensiones *Dimensions*
58 x 500 x 120 mm



16509.B

Toallero doble *Double towel rail*
Dimensiones *Dimensions*
45 x 450 x 122 mm Tubo *Tube* Ø 16 mm



16510.B

Toallero doble *Double towel rail*
Dimensiones *Dimensions*
45 x 600 x 122 mm Tubo *Tube* Ø 16 mm



16501.B

Toallero *Towel rail*
Dimensiones *Dimensions*
45 x 520 x 70 mm
Tubo *Tube* Ø 16 mm

16502.B

Toallero *Towel rail*
Dimensiones *Dimensions*
45 x 670 x 70 mm
Tubo *Tube* Ø 16 mm

16503.B

Toallero *Towel rail*
Dimensiones *Dimensions*
45 x 830 x 70 mm
Tubo *Tube* Ø 16 mm

Material Zamac *Material Zamac*
Acabado BRILLO *POLISH finished (.B)*

PÁDUA



16507.B

Perchero de cuatro perchas
Four hooks towel rack
Dimensiones *Dimensions*
40 x 200 x 31 mm



16508.B

Perchero de siete perchas
Seven hooks towel rack
Dimensiones *Dimensions*
27 x 540 x 41 mm



16506.B

Percha
Hook
Dimensiones *Dimensions*
57,5 x 45 x 67,5 mm



16500.B

Portarrollos de papel higiénico
Toilet paper dispenser
Dimensiones *Dimensions*
160 x 140 x 80 mm



16505.B

Reserva portarrollos
Toilet paper reserve
Dimensiones *Dimensions*
165 x 45 x 70 mm



16519.B

Portarrollos reserva
Toilet paper reserve
Dimensiones *Dimensions*
180 x 60 x 95 mm



16518.B

Escobillero
Toilet brush
Dimensiones *Dimensions*
365 x 155 x 118 mm

HOTEL

Material Zamac *Material Zamac*
Acabado BRILLO POLISH finished (.B)



16407.B

Aro toallero
Towel hoop

Dimensiones *Dimensions*
190 x 155 x 45 mm



16415.B

Repisa de vidrio
Glass utility shelf

Dimensiones *Dimensions*
54 x 582 x 104 mm



16406.B

Repisa toallero con barra inferior
Towel shelf with lower bar

Dimensiones *Dimensions*
119 x 655 x 206 mm



16401.B

Toallero
Towel rail

Dimensiones *Dimensions*
55 x 450 x 80 mm
Tubo *Tube* Ø 20 mm

16402.B

Toallero
Towel rail

Dimensiones *Dimensions*
55 x 650 x 80 mm
Tubo *Tube* Ø 20 mm



16408.B

Toallero doble abatible
Double swivel towel rail

Dimensiones *Dimensions*
55 x 435 x 45 mm
Tubo *Tube* Ø 20 mm



16404.B

Toallero doble
Double towel rail

Dimensiones *Dimensions*
54 x 450 x 72 mm
Tubo *Tube* Ø 20 mm

16405.B

Toallero doble
Double towel rail

Dimensiones *Dimensions*
54 x 600 x 72 mm
Tubo *Tube* Ø 20 mm

Material Zamac *Material Zamac*
Acabado BRILLO POLISH finished (.B)

HOTEL



16412.B

Jabonera
Soap dish
Dimensiones *Dimensions*
125 x 54 x 95 mm



16413.B

Jabonera de vidrio con soporte mural
Glass soap dish with wall support
Dimensiones *Dimensions*
108 x 54 x 140 mm



16410.B

Vaso para cepillos de dientes con soporte a pared
Glass for toothbrush with wall support
Dimensiones *Dimensions*
95 x 67 x 115 mm



16417.B

Portarrollos de papel higiénico
Toilet paper dispenser
Dimensiones *Dimensions*
170 x 60 x 170 mm



16416.B

Portarrollos de papel higiénico
Toilet paper dispenser
Dimensiones *Dimensions*
54 x 218 x 80 mm



16411.B

Portarrollos reserva
Toilet paper reserve
Dimensiones *Dimensions*
125 x 54 x 95 mm



16409.B

Percha
Hook
Dimensiones *Dimensions*
Ø 55 mm, 45 mm



16419.B

Percha doble
Double hook
Dimensiones *Dimensions*
55 x 55 x 45 mm



16418.B

Escobillero, recipiente de cerámica blanca
Toilet brush, white ceramic container
Dimensiones *Dimensions*
425 x 110 x 138 mm

JABONERAS

SOAP BASKETS

Acabado BRILLO (.B) POLISH finished (.B)
Material Latón cromado Material Chromed brass



09054.B

Jabonera rectangular
Rectangular soap dish
Dimensiones Dimensions
92 x 259 x 124 mm



09055.B

Jabonera rectangular
Rectangular soap dish
Dimensiones Dimensions
30 x 155 x 107 mm

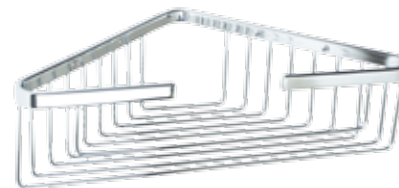

09052.B

Jabonera triangular
Triangular soap dish
Dimensiones Dimensions
48 x 215 x 142 mm

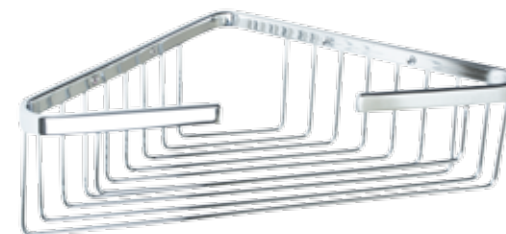

09053.B

Jabonera triangular
Triangular soap dish
Dimensiones Dimensions
90 x 340 x 205 mm



09062.B

Jabonera rectangular
Rectangular soap dish
Dimensiones Dimensions
85 x 350 x 120 mm



09063.B 09063.S

Jabonera triangular
Triangular soap dish
Dimensiones Dimensions
55 x 305 x 225 mm



09064.B 09064.S

Jabonera rectangular
Rectangular soap dish
Dimensiones Dimensions
60 x 250 x 115 mm

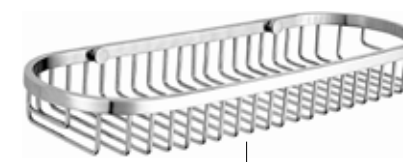

09065.B

Jabonera rectangular
Rectangular soap dish
Dimensiones Dimensions
40 x 355 x 120 mm

Acabado SATINADO (.S) BRILLO (.B) Finish SATIN (.S) POLISH (.B)
Material Acero inoxidable Material Stainless steel

Acabado SATINADO (.S) BRILLO (.B) Finish SATIN (.S) POLISH (.B)

COMPLEMENTOS BAÑO

BATHROOM COMPLEMENTS



18010

Bascula electrónica,
base de vidrio templado
*Electronic scale,
tempered glass base*
Dimensiones *Dimensions*
145 x 270 x 50 mm



04024.B

Dispensador de pañuelos de papel en superficie
Surface mounted tissue dispenser
Material Acero cromado
Material Chromed steel
Dimensiones *Dimensions*
145 x 270 x 50 mm



09022.B

Percha con tope para puertas
Hook with doorstop
Dimensiones *Dimensions*
67 x 117 x 72 mm

04050.S 04050.B

Dispensador de bolsas higiénicas
Hygienic bag dispenser
Material Acero inoxidable
Material Stainless steel
Dimensiones *Dimensions*
136 x 95 x 23 mm



09058.B

Tendedero retráctil (2 m)
Retractable clothes PADUA
(2 m) Dimensiones
Dimensions Ø 90 mm, 55
mm



N

I-SET





Secadores de

CABELLO

Hair dryers

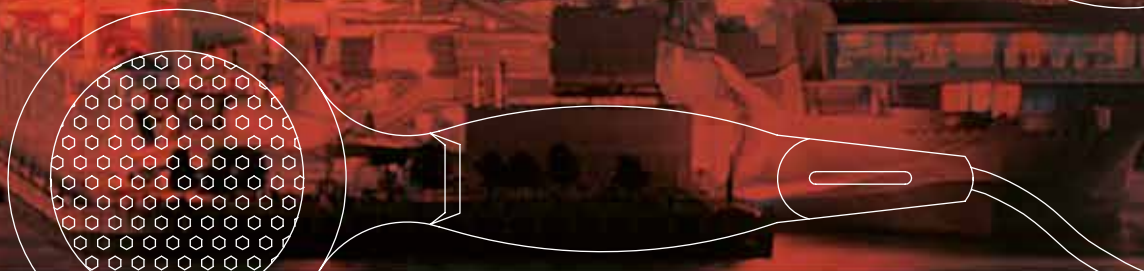

HOTEL LINE

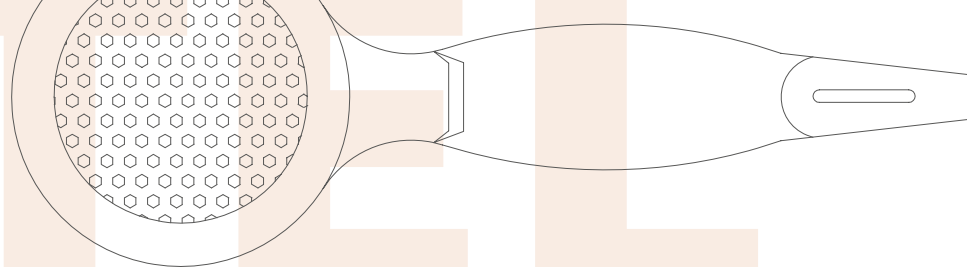

Interruptor ON/OFF y dos velocidades
Pulsador de seguridad de presión continua
ON/OFF switch and two speeds
Security push button continuous pressure



02055.N

Acabado carcasa NEGRO
Casing Finish BLACK
Dimensiones Dimensions
225 x 90 x 165 mm
Peso Weight 0'85 Kg
Potencia Power 1200 W



02055.W

Acabado carcasa BLANCO
Casing Finish WHITE
Dimensiones Dimensions
225 x 90 x 165 mm
Peso Weight 0'85 Kg
Potencia Power 1200 W



02055.G

Acabado carcasa GRIS
Casing Finish GREY
Dimensiones Dimensions
225 x 90 x 165 mm
Peso Weight 0'85 Kg
Potencia Power 1200 W



02011.W

Acabado carcasa BLANCO
Casing Finish BLANCO
Dimensiones Dimensions
185 x 248 x 138 mm
Peso Weight 0,85 Kg
Potencia Power 1800 - 2200 W



02012.W

Con enchufe para afeitadoras
With plug for shaver
Acabado carcasa BLANCO
Casing Finish WHITE
Dimensiones Dimensions
233 x 248 x 155 mm
Peso Weight 1,4 Kg
Potencia Power 1800 - 2200 W



02057

Interruptor ON/OFF, dos velocidades y dos temperaturas.
 Pulsador de seguridad de presión continua.
ON/OFF switch, two speeds and two temperatures.
Security push button continuous pressure.
 Carcasa cromada con aro de soporte a pared
Chromed casing and wall support ring
 Dimensiones *Dimensions*
 220 x 245 x 118 mm
 Peso *Weight* 0,9 Kg
 Potencia *Power* 1800 W



02013

Interruptor ON/OFF, dos velocidades y dos temperaturas.
 Pulsador de seguridad de presión continua.
ON/OFF switch, two speeds and two temperatures.
Security push button continuous pressure
 Carcasa cromada
Chromed casing
 Dimensiones *Dimensions*
 215 x 210 x 93 mm
 Peso *Weight* 0,8 Kg
 Potencia *Power* 1800 W



02010.W

Plegable. Con dos velocidades y botón de aire frío.
Foldable. Two speeds and cool air setting
 Acabado carcasa BLANCO
Casing Finish WHITE
 Dimensiones *Dimensions*
 230 x 80 x 180 mm.
 Plegado *Folded*
 130 x 80 x 180 mm.
 Peso *Weight* 0,85 Kg
 Potencia *Power* 1600 W



02014

Anilla soporte para colgar secadores 02010.W y 02013. Latón cromada acabado brillo
Ring support to hang-up 02010.W and 02013 hair dryer. Polish finished chromed brass
 Dimensiones *Dimensions*
 20 x 80 x 120 mm
 Diámetro interior anilla: 70 mm
Inner diameter: 70 mm
 Separación puntos pared: 40 mm
Wall supports separation: 40 mm



Mirrors

ESPEJOS

Material Latón cromado *Material Chromed brass*
Acabado brillo *Polish finished*

ESPEJOS

MIRRORS



08012
Espejo regulable en altura
Adjustable height mirror
Material ABS cromado
Material Chromed ABS
Dimensiones *Dimensions*
535 x 205 x 125 mm
Ø espejo *mirror* 160 mm



08007
Espejo extensible de aumento con
dos caras. Visión normal y x2
*Extensible magnifying mirror with two
faces. Normal vision and x2*
Dimensiones *Dimensions*
300 x 175 x 20 mm
desplegado *extended*
310 x 400 x 40 mm
Ø espejo *mirror* 140 mm



08014
Espejo extensible de aumento x3
Iluminación LED
*Extensible magnifying mirror x3
LED lighting*
Dimensiones *Dimensions*
desplegado *extended*
215 x 450 x 80 mm
Ø espejo *mirror* 160 mm



08009.2
Espejo extensible de aumento
con dos caras. Visión normal y x3
*Extensible magnifying mirror with
two faces. Normal vision and x3*
Dimensiones *Dimensions*
Desplegado *Extended*
300 x 450 x 40
Ø espejo *mirror* 200 mm



Complementos de

BAÑO

Bathroom complements



TOALLEROS ELÉCTRICOS

ELECTRIC TOWEL RAILS

Material Acero inoxidable *Material Stainless steel*
Acabado BRILLO *POLISH finished*
Potencia *Power* 65 W con enchufe *with plug*

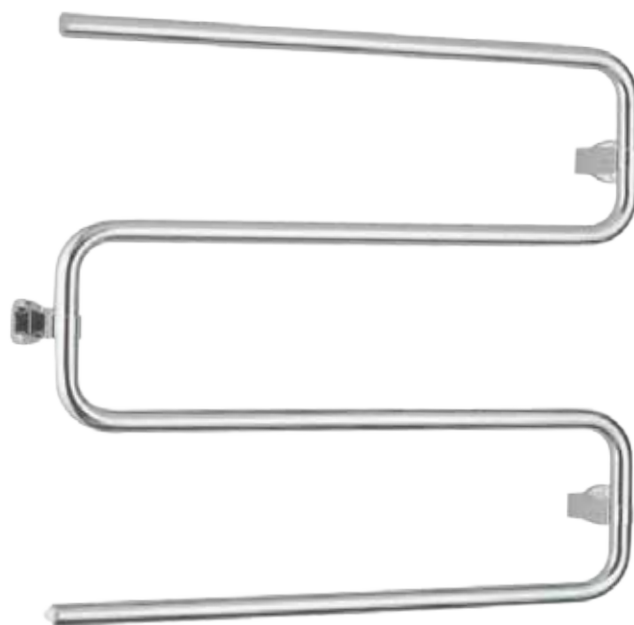

18002

Dimensiones *Dimensions*

750 x 610 x 85 mm

Ø tubo *tube* 25 mm



18003

Con interruptor ON/OFF *With switch ON/OFF*

Dimensiones *Dimensions*

550 x 600 x 120 mm

Ø tubo *tube* 32-22 mm

TABURETES BAÑO

BATH STOOLS



15036

Material *Material* ABS
Dimensiones *Dimensions*
440 x 390 x 390 mm



15037

Material *Material* Polipropileno blanco
Material White polypropylene
Patas ajustables de aluminio
Adjustable aluminium legs
Dimensiones *Dimensions*
450-550 x 350 x 369 mm



15038

Material *Material* Polipropileno blanco
Material White polypropylene
Patas de acero inoxidable AISI 304
AISI 304 Stainless steel legs
Dimensiones *Dimensions*
400 x 420 x 350 mm

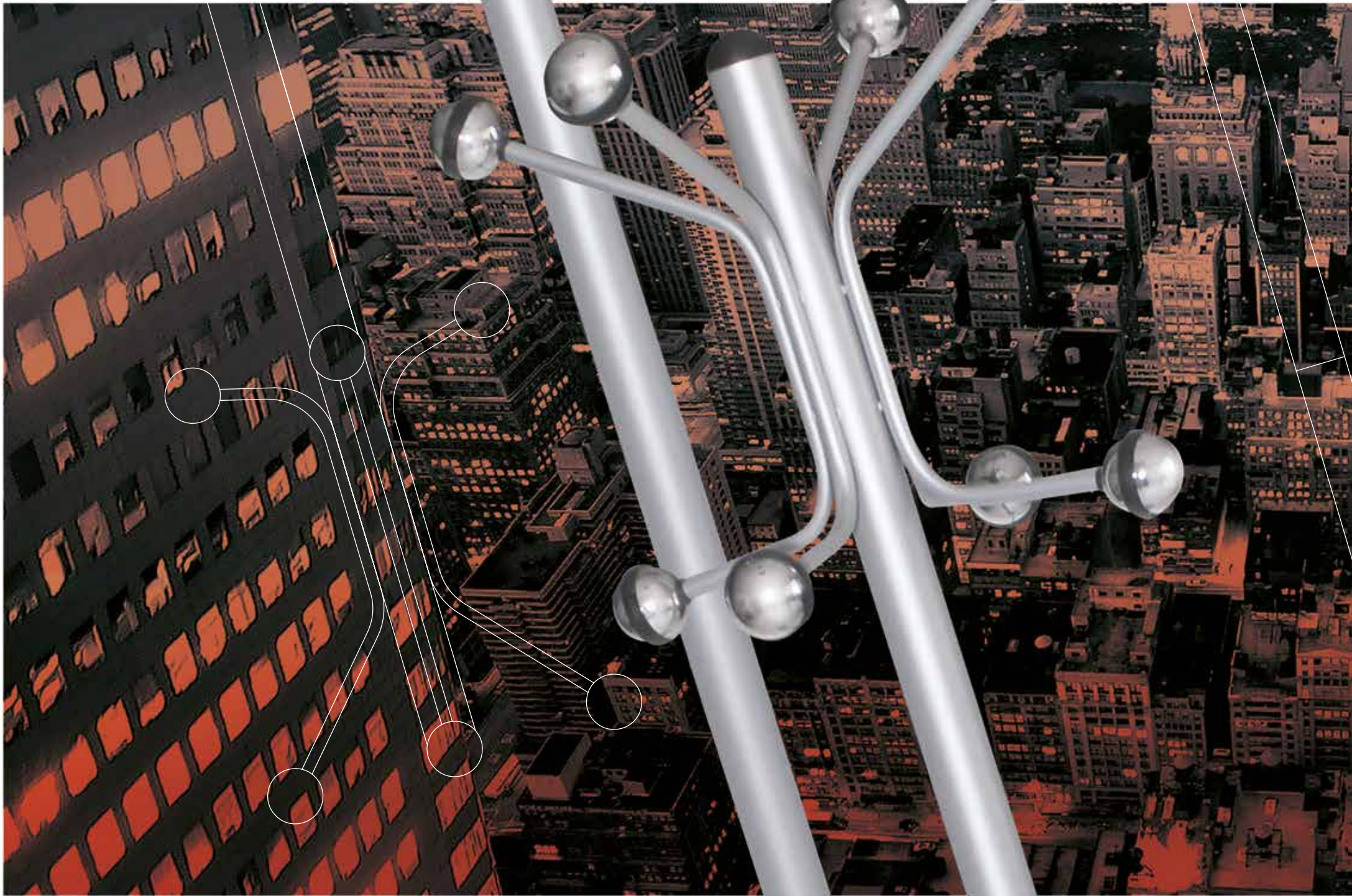

An aerial photograph of a dense urban street grid, likely in New York City, captured during the golden hour of sunset. The buildings are illuminated with a warm, orange-red glow, while the shadows are deep and dark. The sky is not visible, focusing the viewer's attention on the architectural details and the perspective of the streets. Overlaid on the top half of the image is the word "PERCHEROS" in a large, bold, white, sans-serif font. The letters are slightly spaced out and have a thin white outline. Below the main title, the words "Coat racks" are written in a smaller, white, cursive script font. In the bottom left corner, there are several white, thin-lined geometric shapes, including a circle and a line, which appear to be part of a design or branding element.

PERCHEROS

Coat racks

PERCHEROS

COAT RACKS

Material Acero pintado epoxy
Material Epoxy painted steel

36



14178

Perchero de pie metálico con 8 colgadores cromados
Free-standing metal coat hanger with 8 chromed hangers

Dimensiones *Dimensions*
1770 alto, Ø 380 mm



14184

Perchero de pie metálico con 8 colgadores cromados.
Desmontable en dos partes.
Free-standing metal coat hanger with 8 chromed hangers. Detachable in two parts.

Dimensiones *Dimensions*
1770 alto, Ø 380 mm



18205

Perchero portátil de tubo de acero.
Capacidad para hasta 40 perchas. Cuatro ruedas.
Portable epoxy painted steel pipe. Capacity up to 40 hangers. Four wheels.

Dimensiones *Dimensions*
1710 x 1480 x 580 mm

Dim.: x x x

www.HI-SET.com

Material Acero pintado epoxy
Material Epoxy painted steel

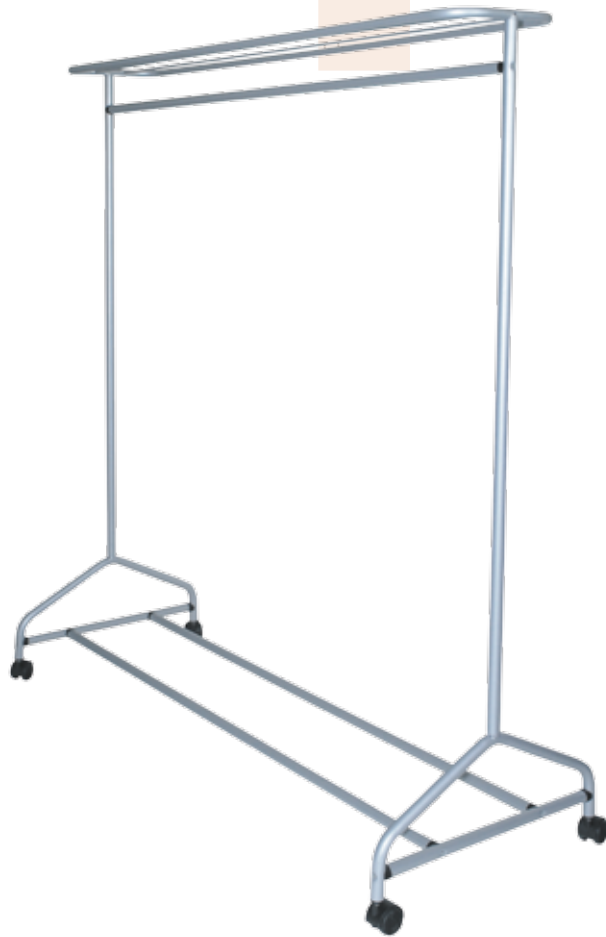

18206

Perchero portátil de tubo de acero con repisa superior.
Capacidad para hasta 40 perchas. Cuatro ruedas.

*Portable epoxy painted steel pipe with upper shelf.
Capacity up to 40 hangers. Four wheels.*

Dimensiones *Dimensions*
1710 x 1480 x 580 mm



14176

Perchero-paraguero metálico con ocho colgadores
de color negro. Desmontable en dos partes.

*Metal hanger-umbrella stand with eight black
color hangers. Detachable in two parts.*

Dimensiones *Dimensions*
1770 alto, Ø 300 mm



14173.N

Perchero de pie con seis colgadores
de ABS. Color negro

*Free-standing hanger with six ABS
hangers. Black color.*

Dimensiones *Dimensions*
1700 alto, Ø 300 mm

PERCHEROS

COAT RACKS



14173.P

Perchero de pie con seis colgadores
de ABS. Color gris plata

*Free-standing hanger with six ABS
hangers. Silver grey color.*

Dimensiones *Dimensions*
1700 alto, Ø 300 mm



MIRAR DESDE LA VENTANA DE NUESTRA HABITACIÓN Y SORPRENDERNOS GRATAMENTE POR EL PAISAJE, URBANO O RURAL, DEBE PRODUCIRNOS IGUAL SENSACIÓN QUE MIRAR DE PUERTAS ADENTRO DE NUESTRA ESTANCIA.

LOOKING FROM THE WINDOW OF OUR ROOM AND BEING PLEASANTLY SURPRISED BY THE LANDSCAPE, URBAN OR RURAL, MAY CAUSE US THE SAME FEELING AS LOOKING BEHIND CLOSED DOORS OF OUR STAY.

MIREMOS...

LOOK AROUND...



PAPELERAS

Bins



PAPELERAS

BINS

Cubeta higiénica con pedal. Cubo interior de plástico con asa
Pedal operated, tip-open wastepaper bin. Interior plastic pail with handle
Material .S y .B: acero inoxidable, .W: acero Material .S and .B: stainless steel, .W: steel
Acabados SATINADO (.S), BRILLO (.B), BLANCO (.W) Finishes SATIN (.S), POLISH (.B), WHITE (.W)

42



09100.S 09100.B 09100.W

Dimensiones *Dimensions*
257 mm, Ø 170 mm
Capacidad *Capacity*
3 litros *litres*

09101.S 09101.B 09101.W

Dimensiones *Dimensions*
270 mm, Ø 205 mm
Capacidad *Capacity*
5 litros *litres*

09102.S 09102.B 09102.W

Dimensiones *Dimensions*
390 mm, Ø 250 mm
Capacidad *Capacity*
12 litros *litres*

Cubeta higiénica con pedal. Cubo interior de plástico con asa
Pedal operated, tip-open wastepaper bin. Interior plastic pail with handle
 Material .S y .B: acero inoxidable, .W: acero *Material .S and .B: stainless steel, .W: steel*
 Acabados SATINADO (.S), BRILLO (.B), BLANCO (.W) *Finishes SATIN (.S), POLISH (.B), WHITE (.W)*

PAPEREL

PAPELERAS

BINS



09103.S 09103.B 09103.W

Dimensiones *Dimensions*
 456 mm, Ø 293 mm
 Capacidad *Capacity*
 20 litros *litres*

09104.S 09104.B 09104.W

Dimensiones *Dimensions*
 625 mm, Ø 293 mm
 Capacidad *Capacity*
 30 litros *litres*

09110.S 09110.B

Dimensiones *Dimensions*
 395 x 275 x 280 mm
 Capacidad *Capacity*
 12 litros *litres*

COMPLEMENTOS

Complements



COMPLEMENTOS

COMPLEMENTS



18115

Reposamaletas

Luggage rack

Material Acero cromado-cintas nylon

Material Chromed steel-nylon belts

Dimensiones *Dimensions*

525 x 640 x 410 mm



18116

Reposamaletas con respaldo

Luggage rack with backrest

Material Acero cromado-cintas nylon

Material Chromed steel-nylon belts

Dimensiones *Dimensions*

680 x 640 x 410 mm



18117

Reposamaletas

Luggage rack

Material Acero cromado-polipiel

Material Chromed steel-faux leather

Dimensiones *Dimensions*

568 x 550 x 456 mm





LAS ESPECTATIVAS DEL HOTEL SON LAS NECESIDADES DEL USUARIO, LA CALIDAD Y ESTÉTICA IMAGINADA UN DÍA SOBRE UN PAPEL TOMA VIDA CON LA ELECCIÓN DEL PRODUCTO DESEADO. LA PROPUESTA DE LAS ZONAS CUMUNES ES NUESTRO " NOMBRE PROPIO" EN LA TARJETA DE PRESENTACIÓN AL CLIENTE.

HOTEL'S EXPECTATIONS ARE THE USER'S REQUIREMENTS, THE QUALITY AND AESTHETICS IMAGINED SOMEDAY ON A SHEET OF PAPER TURNS INTO REALITY BY CHOOSING THE DESIRED PRODUCT. THE PROPOSAL OF THE COMMON AREAS IS OUR "OWN NAME" ON THE PRESENTATION'S CARD TO THE CLIENT.

SOMOS... *WE ARE...*



NOBER®

Secadores de

CABELLO

Hair dryers



ZONDA



Funcionamiento Tipo tobera con pulsador *Operation Nozzle type with push button*
Dimensiones *Dimensions* 240 x 265 x 230 mm - Peso *Weight* 6 kg
Potencia *Power* 2450W - Temporización pulsador *Working Time* 90s
Carcasa Espesor *Casing thickness* 1,2mm



02200.S

Carcasa Acero inoxidable AISI 304
AISI 304 Stainless steel casing
Acabado SATINADO
SATIN Finished



02200.B

Carcasa Acero inoxidable AISI 304
AISI 304 Stainless steel casing
Acabado BRILLO
Polish finished



02200.W

Carcasa Acero
Steel casing
Acabado BLANCO
WHITE Finished

Funcionamiento Manguera con pulsador *Operation Handle with push button*
Dimensiones *Dimensions* 240 x 310 x 165 mm - Peso *Weight* 6 kg
Potencia *Power* 950W - Temporización pulsador *Working Time* 90s
Carcasa Espesor *Casing thickness* 1,2mm



MANGO

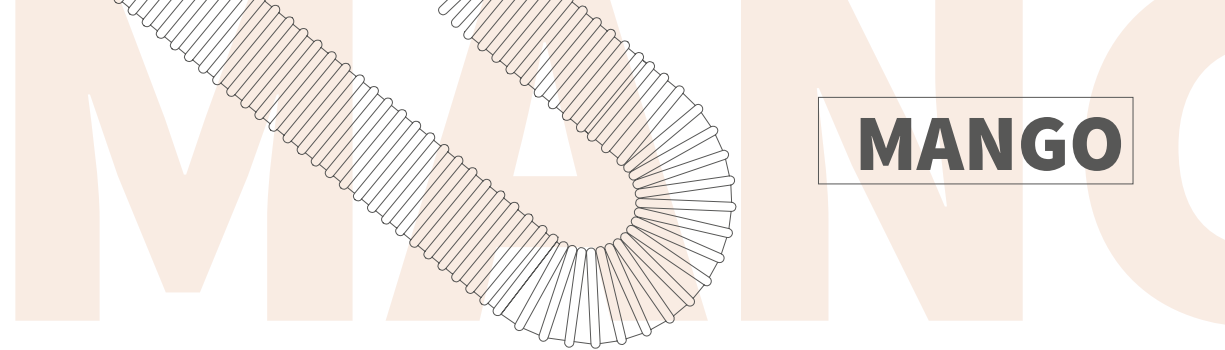

02100.S

Carcasa Acero inoxidable AISI 304
AISI 304 Stainless steel casing
Acabado SATINADO
SATIN Finished



02100.B

Carcasa Acero inoxidable AISI 304
AISI 304 Stainless steel casing
Acabado BRILLO
Polish finished



02100.W

Carcasa Acero
Steel casing
Acabado BLANCO
WHITE Finished



A city skyline at night with a hand dryer in the foreground. The hand dryer is a sleek, white, modern design with a curved, ergonomic shape. The city buildings are illuminated with warm orange and yellow lights, creating a vibrant contrast against the dark sky. The overall composition is a blend of modern technology and urban architecture.

Seca

MANIOS

Hand dryers

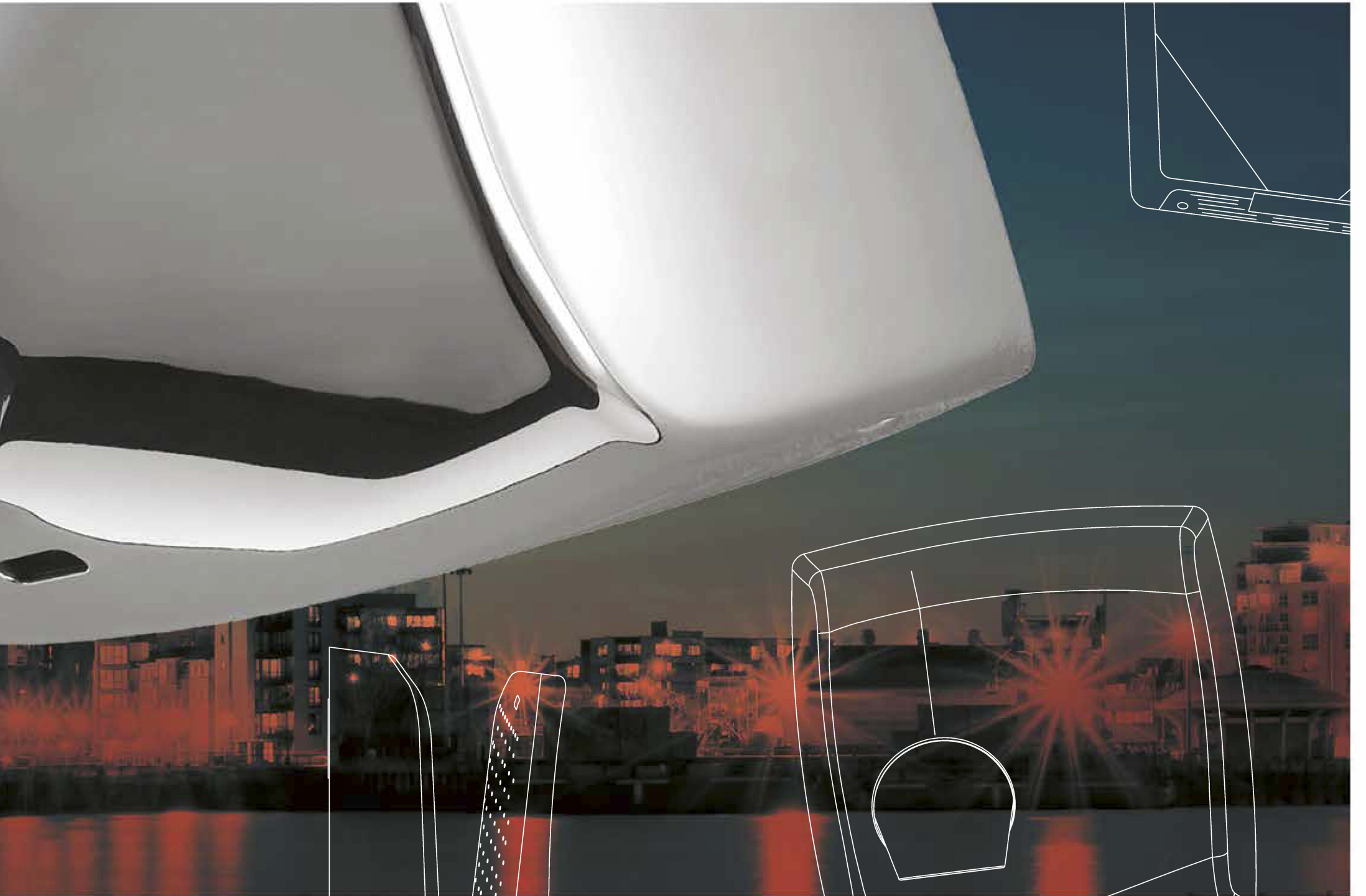

V-JET



Sistema de secado antisalpicaduras mediante corrientes de aire de alta velocidad. No es necesario insertar las manos una y otra vez.
Modo de uso: introduzca las manos en el área de secado, espere unos segundos y saque las manos secas.
Non splash drying system. No need to take the hands out and put them in over and over.
Mode of use: Put the hands into the drying area, wait for a few seconds and take the dry hands out.
Dimensiones *Dimensions* 617 x 300 x 195 mm - Peso *Weight* 9,55 Kg - Potencia *Power* 1760 W

2 AÑOS
DE GARANTÍA



54



01303.W

Acabado *Finished*
Snow white



01303.S

Acabado *Finished*
Aluminium



01303.CH

Acabado *Finished*
Groc Champagne



01303.B

Acabado *Finished*
Chrome Glossy



01303.BK

Acabado *Finished*
Black BCK



01303.AB

Acabado *Finished*
Atlantic Blue



01303.DB

Acabado *Finished*
Deep Blue



01303.RF

Acabado *Finished*
Red F1



01303.CR

Acabado *Finished*
Cherry Red



01303.BD

Acabado *Finished*
Bordeaux

300 ORIFICIOS
SALIDA DE AIRE
300 AIR OUTLET
OPENINGS

ANTI
SALPICADURAS
NON-SPLASH

ANTIBACTERIAS
MICROBAN®
ANTIBACTERIA
MICROBAN®

Sistema de secado ultrarrápido mediante corrientes de aire de alta velocidad.

Ultra-fast drying system by high speed air currents.

Dimensiones *Dimensions* 617 x 300 x 195 mm - Peso *Weight* 9,55 Kg - Potencia *Power* 1760 W



V-JET TRIBLADE

2 AÑOS
DE GARANTÍA



01305.W

Acabado *Finished*
Snow white



01305.S

Acabado *Finished*
Aluminium



01305.CH

Acabado *Finished*
Groc Champagne



01305.B

Acabado *Finished*
Chrome Glossy



01305.BK

Acabado *Finished*
Black BCK



01305.AB

Acabado *Finished*
Atlantic Blue



01305.DB

Acabado *Finished*
Deep Blue



01305.RF

Acabado *Finished*
Red F1



01305.CR

Acabado *Finished*
Cherry Red



01305.BD

Acabado *Finished*
Bordeaux



2 LÍNEAS
DE INYECCIÓN
2 INJECTION
LINES

ANTIBACTERIAS
MICROBAN®
ANTIBACTERIA
MICROBAN®

SECADO
ULTRARRÁPIDO
6 SEGUNDOS
ULTRA-FAST
DRYING 6
SECONDS



WINDFLOW



Funcionamiento Sensor electrónico *Automatic operation*
Dimensiones *Dimensions* 280 x 280 x 210 mm - Peso *Weight* 5,5 Kg - Potencia *Power* 2450 W
Carcasa Versión acero inoxidable: espesor 1,5 mm. Versión acero: espesor 1,2 mm
Casing 1,5 mm thickness stainless steel version. 1,2 mm steel version

Vandal-proof *Antivandálico*

3 AÑOS
DE GARANTÍA



01151.S

Carcasa Acero inoxidable AISI 304
AISI 304 Stainless steel Casing
Acabado SATINADO
SATIN Finished



01151.B

Carcasa Acero inoxidable AISI 304
AISI 304 Stainless steel Casing
Acabado BRILLO
POLISH Finished



01151.W

Carcasa Acero *Steel Casing*
Acabado BLANCO
WHITE Finished

Funcionamiento Pulsador / Sensor electrónico *Operation Push Button / Automatic*
Dimensiones *Dimensions* 240 x 265 x 210 mm - Peso *Weight* 5,5 Kg - Potencia *Power* 2450 W
Carcasa Espesor 1,2 mm *Casing thickness* 1,2 mm



CYCLON

Vandal-proof *Antivandálico*

2 AÑOS
DE GARANTÍA



01101.S

Sensor electrónico
Automatic
Carcasa acero inoxidable AISI 304
AISI 304 stainless steel casing
Acabado SATINADO
SATIN finished

01100.S

Pulsador
Push button
Carcasa acero inoxidable AISI 304
AISI 304 stainless steel casing
Acabado SATINADO
SATIN finished

01101.B

Sensor electrónico
Automatic
Carcasa acero inoxidable AISI 304
AISI 304 stainless steel casing
Acabado BRILLO
POLISH finished

01100.B

Pulsador
Push button
Carcasa acero inoxidable AISI 304
AISI 304 stainless steel casing
Acabado BRILLO
POLISH finished

01101.W

Sensor electrónico
Automatic
Carcasa acero Steel casing
Acabado BLANCO
WHITE finished

01100.W

Pulsador
Push button
Carcasa acero Steel casing
Acabado BLANCO
WHITE finished



THIN

2 AÑOS

DE GARANTÍA



Funcionamiento sensor electrónico *Automatic operation*
Dimensiones *Dimensions* 269 x 363 x 100 mm - Peso *Weight* 4 Kg - Potencia *Power* 2350 W
Espesor carcasa *Casing thickness* 1,2 mm



01600.S

Carcasa acero inoxidable AISI 304
AISI 304 stainless steel casing
Acabado SATINADO
SATIN finished



01600.B

Carcasa acero inoxidable AISI 304
AISI 304 stainless steel casing
Acabado BRILLO
POLISH finished



01600.W

Carcasa acero *Steel casing*
Acabado BLANCO
WHITE finished

Funcionamiento sensor electrónico *Automatic operation*
Potencia *Power* 800 W



FUGA

2 AÑOS
DE GARANTÍA



01851.S

Carcasa acero inoxidable AISI 304. Espesor 1,2 mm
AISI 304 stainless steel casubg. Thickness 1,2 mm
Acabado SATINADO
SATIN finished
Dimensiones *Dimensions*
327 x 253 x 152 mm
Peso *Weight* 4,9 Kg



01851.B

Carcasa acero inoxidable AISI 304. Espesor 1,2 mm
AISI 304 stainless steel casubg. Thickness 1,2 mm
Acabado BRILLO
POLISH finished
Dimensiones *Dimensions*
327 x 253 x 152 mm
Peso *Weight* 4,9 Kg



01851.W

Carcasa acero. Espesor 1,2 mm
Steel casing. Thickness 1,2 mm
Acabado BLANCO
WHITE finished
Dimensiones *Dimensions*
327 x 253 x 152 mm
Peso *Weight* 4,9 Kg



01861.W

Carcasa ABS
ABS casing
Acabado BLANCO
WHITE finished
Dimensiones *Dimensions*
328 x 255 x 155 mm
Peso *Weight* 3,6 kg



KAI



SGS



SEC

Dimensiones *Dimensions* 240 x 280 x 168 mm - Peso *Weight* 3,4 kg - Potencia *Power* 1500 W
Espesor carcasa *Casing thickness* 1 mm

2 AÑOS
DE GARANTÍA



01250.S

Sensor electrónico
Automatic
Carcasa acero inoxidable AISI 304
AISI 304 stainless steel casing
Acabado SATINADO
SATIN finished

01251.S

Pulsador
Push button
Carcasa acero inoxidable AISI 304
AISI 304 stainless steel casing
Acabado SATINADO
SATIN finished

01250.B

Sensor electrónico
Automatic
Carcasa acero inoxidable AISI 304
AISI 304 stainless steel casing
Acabado BRILLO
POLISH finished

01251.B

Pulsador
Push button
Carcasa acero inoxidable AISI 304
AISI 304 stainless steel casing
Acabado BRILLO
POLISH finished

01250.W

Sensor electrónico
Automatic
Carcasa acero
Steel casing
Acabado BLANCO
WHITE finished

01251.W

Pulsador
Push button
Carcasa acero
Steel casing
Acabado BLANCO
WHITE finished

Funcionamiento Sensor electrónico *Operation automatic*
Potencia *Power* 2050 W



BIGFLOW

2 AÑOS
DE GARANTÍA



01451.S

Carcasa acero inoxidable AISI 304. Espesor 1,2 mm
AISI 304 stainless steel casubg. Thickness 1,2 mm
Acabado SATINADO
SATIN finished
Dimensiones *Dimensions*
327 x 253 x 152 mm
Peso *Weight* 3,4 Kg



01451.B

Carcasa acero inoxidable AISI 304. Espesor 1,2 mm
AISI 304 stainless steel casubg. Thickness 1,2 mm
Acabado BRILLO
POLISH finished
Dimensiones *Dimensions*
327 x 253 x 152 mm
Peso *Weight* 3,4 Kg



01451.W

Carcasa acero. Espesor 1,2 mm
Steel casing. Thickness 1,2 mm
Acabado BLANCO
WHITE finished
Dimensiones *Dimensions*
327 x 253 x 152 mm
Peso *Weight* 3,4 kg



01461.W

Carcasa ABS
ABS casing
Acabado BLANCO
WHITE finished
Dimensiones *Dimensions*
328 x 255 x 155 mm
Peso *Weight* 2,5 kg





Dosificadores de

JABÓN

Soap dispensers



DOSIFICADORES

SOAP DISPENSERS

Dosificador para jabón líquido, adosado horizontal *Wall mounted horizontal dispenser for liquid soap*
Anti-goteo *Anti-drip* Visor de contenido *Level viewer*
Material acero inoxidable AISI 304 *Material AISI 304 stainless steel* Capacidad *Capacity* 1200 ml



03004.S

Dimensiones *Dimensions*
155 x 175 x 125 mm
Acabado SATINADO
SATIN finished



03004.B

Dimensiones *Dimensions*
155 x 175 x 125 mm
Acabado BRILLO
POLISH finished



03004.W

Dimensiones *Dimensions*
155 x 175 x 125 mm
Acabado BLANCO
WHITE finished



03002.S

Dimensiones *Dimensions*
121 x 210 x 70 mm
Acabado SATINADO
SATIN finished



03002.B

Dimensiones *Dimensions*
121 x 210 x 70 mm
Acabado BRILLO
POLISH finished



03002.W

Dimensiones *Dimensions*
121 x 210 x 70 mm
Acabado BLANCO
WHITE finished

Dosificador para jabón líquido, adosado vertical Wall mounted vertical dispenser for liquid soap
Anti-goteo Anti-drip Material acero inoxidable AISI 304 Material AISI 304 stainless steel

DOSIFICADORES

SOAP DISPENSERS



03041.S

Con depósito interior plástico y visor de contenido

With inner plastic container level viewer

Dimensiones Dimensions

210 x 121 x 70 mm

Acabado SATINADO SATIN finished

Capacidad Capacity 1200ml



03041.B

Con depósito interior plástico y visor de contenido

With inner plastic container level viewer

Dimensiones Dimensions

210 x 121 x 70 mm

Acabado BRILLO POLISH finished

Capacidad Capacity 1200ml



03041.W

Con depósito interior plástico y visor de contenido

With inner plastic container level viewer

Dimensiones Dimensions

210 x 121 x 70 mm

Acabado BLANCO WHITE finished

Capacidad Capacity 1200ml



03024.S

Dimensiones Dimensions

200 mm. Ø63mm

Acabado SATINADO SATIN finished

Capacidad Capacity 300 ml



03024.B

Dimensiones Dimensions

200 mm. Ø63mm

Acabado BRILLO POLISH finished

Capacidad Capacity 300 ml

03025.S

Dimensiones Dimensions

200 x 60 x 60 mm

Acabado SATINADO SATIN finished

Capacidad Capacity 300 ml



03003.B

Cuerpo de acero inoxidable, cabezal de zamac. Con visor de contenido

Stainless steel housing, zamac head. With level viewer

Dimensiones Dimensions

150 x 70 x 150 mm

Acabado BRILLO POLISH finished

Capacidad Capacity 345 ml



03022.S

Con visor de contenido

With level viewer

Dimensiones Dimensions

160 x 105 x 91 mm

Acabado SATINADO SATIN finished

Capacidad Capacity 820 ml



DOSIFICADORES

SOAP DISPENSERS

Dosificador para jabón líquido *Dispenser for liquid soap*
Material acero inoxidable AISI 304 *Material AISI 304 stainless steel*



03201.S

Encastrado en pared. Vertical.
Visor de contenido.
*Flush mounted. Vertical.
Level viewer.*
Dimensiones *Dimensions*
260 x 150 x 106 mm
Acabado SATINADO *SATIN finished*
Capacidad *Capacity* 1200 ml



03202.S

Encastrado en pared. Horizontal.
Visor de contenido.
*Flush mounted. Horizontal.
Level viewer.*
Dimensiones *Dimensions*
150 x 260 x 106 mm
Acabado SATINADO *SATIN finished*
Capacidad *Capacity* 1200 ml



03100

Encastrado encimera (orificio encimera Ø 25 mm,
embellecedor Ø 50 mm)
*Upper part built-in countertop (countertop hole Ø 25 mm,
decorative top Ø 50 mm)*
Dimensiones *Dimensions*
Pico 100 mm largo. Depósito 100 mm alto. Vástago 100 mm
Spout 100 mm long. Tank 100 mm height. Stem 100 mm
Acabado BRILLO *POLISH finished*
Vástago de acero *Steel stem*
Depósito de acero inoxidable *Stainless steel tank*
Capacidad *Capacity* 500 ml



03101.B

Encastrado encimera (orificio encimera Ø 25 mm,
embellecedor Ø 50 mm)
*Upper part built-in countertop (countertop hole Ø 25 mm,
decorative top Ø 50 mm)*
Dimensiones *Dimensions*
Pico 100 mm largo. Depósito 220 mm alto. Vástago 100 mm
Spout 100 mm long. Tank 220 mm height. Stem 100 mm
Acabado BRILLO *POLISH finished*
Vástago de ABS *ABS stem*
Depósito de polietileno blanco *White polyethylene tank*
Capacidad *Capacity* 1000 ml

Funcionamiento Sensor automático *Operation Automatic sensor*

DOSIFICADORES

SOAP DISPENSERS



03023.S

Material Acero inoxidable AISI 304

Material AISI 304 Stainless steel

Visor de contenido *visor de contenido*

Dimensiones *Dimensions*

210 x 140 x 100 mm

Acabado SATINADO *SATIN finished*

Capacidad *Capacity* 1200 ml



03023.B

Material Acero inoxidable AISI 304

Material AISI 304 Stainless steel

Visor de contenido *visor de contenido*

Dimensiones *Dimensions*

210 x 140 x 100 mm

Acabado BRILLO *POLISH finished*

Capacidad *Capacity* 1200 ml



07250.B

Grifo electrónico

Electronic faucet

Material latón cromado

Material chromed brass

Dimensiones *Dimensions*

142 x 50 x 150 mm



03106.B

Material latón cromado

Material chromed brass

Dimensiones *Dimensions*

104 x 45 x 130 mm



Dispensadores de

PAPPEL

Paper dispensers



PAPEL HIGIÉNICO

TOILET PAPER

Dispensador de papel higiénico para rollo industrial con visor de contenido y cerradura de seguridad
Toilet paper dispenser for industrial roll with level viewer and safety closure with pin tumbler lock
Acabados Satinado (.S), Brillo (.B), Blanco (.W) Finishes Satin (.S), Polish (.B), White (.W)



05001.S

Material Acero inoxidable
Material Stainless steel

Dimensiones Dimensions

260 x 250 x 112 mm

Rollo máx. Max. roll Ø 230 mm

Eje Axle Ø 40 mm

05001.XL.S

Material Acero inoxidable
Material Stainless steel

Dimensiones Dimensions

295 x 285 x 112 mm

Rollo máx. Max. roll Ø 280 mm

Eje Axle Ø 40 mm

05001.B

Material Acero inoxidable
Material Stainless steel

Dimensiones Dimensions

260 x 250 x 112 mm

Rollo máx. Max. roll Ø 230 mm

Eje Axle Ø 40 mm

05001.XL.B

Material Acero inoxidable
Material Stainless steel

Dimensiones Dimensions

295 x 285 x 112 mm

Rollo máx. Max. roll Ø 280 mm

Eje Axle Ø 40 mm

05001.W

Material Acero
Material Steel

Dimensiones Dimensions

260 x 250 x 112 mm

Rollo máx. Max. roll Ø 230 mm

Eje Axle Ø 40 mm

05001.XL.W

Material Acero
Material Steel

Dimensiones Dimensions

295 x 285 x 112 mm

Rollo máx. Max. roll Ø 280 mm

Eje Axle Ø 40 mm

Dispensador de papel higiénico para rollo doméstico *Toilet paper dispenser for domestic roll*
Acabados Satinado (.S), Brillo (.B), Blanco (.W) *Finishes Satin (.S), Polish (.B), White (.W)*

PAPEL HIGIÉNICO

TOILET PAPER



05100.S

Cierre de seguridad *Safety closure*
Material Acero inoxidable AISI 304
Material AISI 304 Stainless steel
Dimensiones *Dimensions*
330 x 120 x 127 mm
Capacidad *Capacity*
3 rollos *rolls*



05100.B

Cierre de seguridad *Safety closure*
Material Acero inoxidable AISI 304
Material AISI 304 Stainless steel
Dimensiones *Dimensions*
330 x 120 x 127 mm
Capacidad *Capacity*
3 rollos *rolls*



05100.W

Cierre de seguridad *Safety closure*
Material Acero
Material Steel
Dimensiones *Dimensions*
330 x 120 x 127 mm
Capacidad *Capacity*
3 rollos *rolls*



05206.B

Doble dispensador de papel higiénico, encastrado. Horizontal
Built-in double toilet paper dispenser. Horizontal
Material Acero inoxidable AISI 304
Material AISI 304 Stainless steel
Dimensiones *Dimensions*
165 x 314 x 75 mm



05202.S

Doble dispensador de papel higiénico, encastrado. Vertical
Built-in double toilet paper dispenser
Cierre de seguridad con cerradura
Safety closure with pin tumbler lock
Material Acero inoxidable AISI 304
Material AISI 304 Stainless steel
Dimensiones *Dimensions*
325 x 195 x 87 mm

PAPEL TOALLA

TOWEL PAPER

Dispensador de papel toalla con visor de contenido y cerradura de seguridad
Towel paper dispenser with level viewer and safety closure with pin tumbler lock
Acabados SATINADO (.S), BRILLO (.B), BLANCO (.W) Finishes SATIN (.S), POLISH (.B), WHITE (.W)



04010.S

Material Acero inoxidable / Material Stainless steel

Dimensiones / Dimensions

320 x 250 x 115 mm

Capacidad / Capacity 500 usos / uses



04010.B

Material Acero inoxidable / Material Stainless steel

Dimensiones / Dimensions

320 x 250 x 115 mm

Capacidad / Capacity 500 usos / uses



04010.W

Material Acero / Material Steel

Dimensiones / Dimensions

320 x 250 x 115 mm

Capacidad / Capacity 500 usos / uses

Dispensadores de papel toalla en bobina tipo mecha. Cerradura de seguridad
Center-pull towel paper roll dispenser. Safety closure with pin tumbler lock
Material Acero inoxidable AISI 304 Material AISI 304 Stainless steel
Acabados SATINADO (.S), BRILLO (.B), BLANCO (.W) Finishes SATIN (.S), POLISH (.B), WHITE (.W)

PAPEL TOALLA EN BOBINA

CENTER-PULL TOWEL PAPER ROLL



04099.B

Dimensiones *Dimensions*
300 x 240 x 210 mm
Rollo máx. *Max. roll*
200 mm, Ø 200 mm



04099.MINI.B

Dimensiones *Dimensions*
300 x 175 x 160 mm
Rollo máx. *Max. roll*
200 mm, Ø 135 mm



04099.S

Dimensiones *Dimensions*
300 x 240 x 210 mm
Rollo máx. *Max. roll*
200 mm, Ø 200 mm



04099.MINI.S

Dimensiones *Dimensions*
300 x 175 x 160 mm
Rollo máx. *Max. roll*
200 mm, Ø 135 mm

HI-SET



Muebles

COMPACTOS

Compact furniture

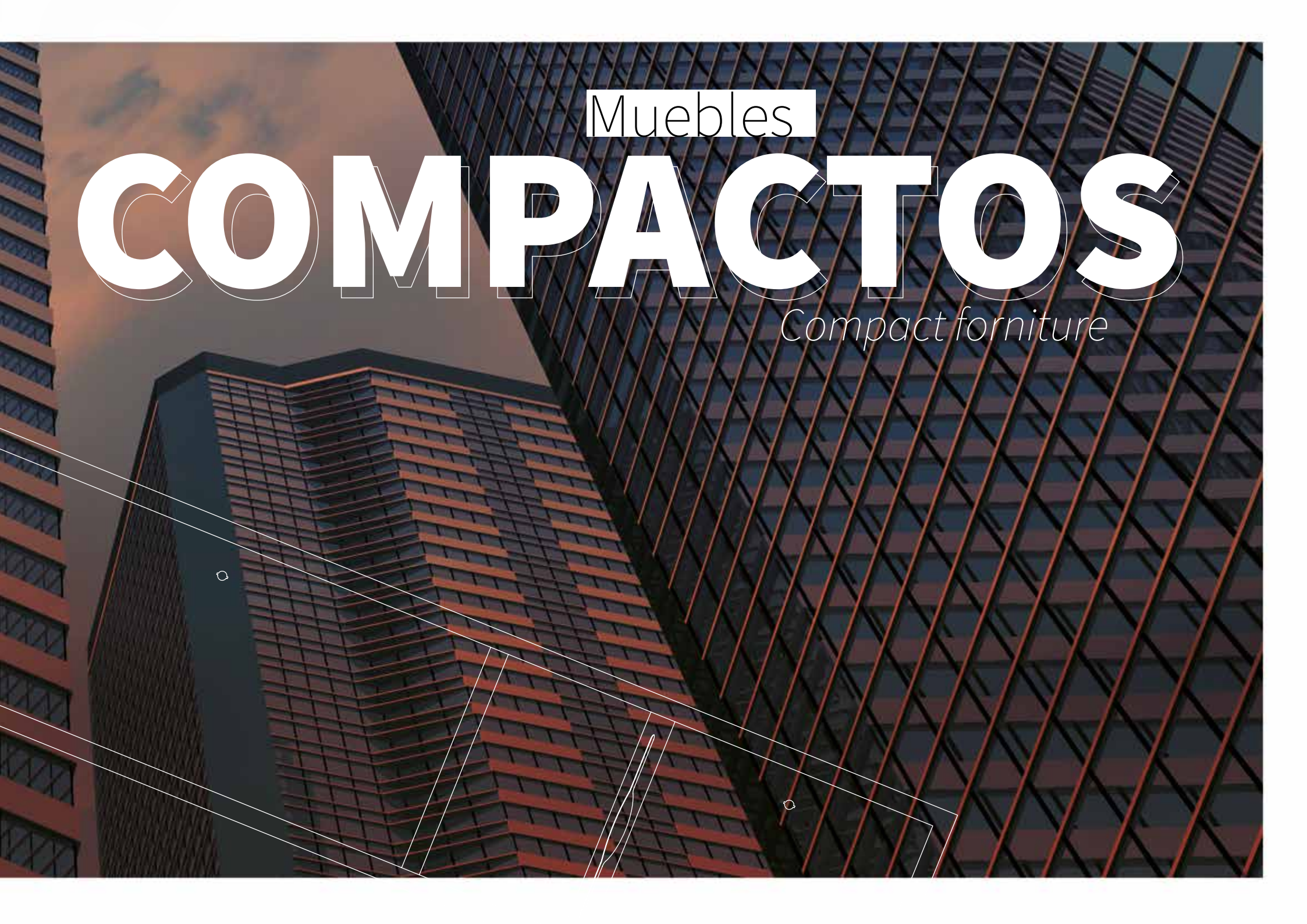

MUEBLES COMPACTOS

COMPACT FURNITURE

Mueble compacto *Compact unit*
Material acero inoxidable AISI 304 *Material AISI 304 stainless steel*
Acabado SATINADO (.S) *SATIN finished (.S)*



12020.S

Mueble empotrado con dispensador de papel toalla y papelerera

Flush mounted unit with towel paper dispenser and bin

Dimensiones *Dimensions*

1375 x 365 x 160 mm

Capacidad *Capacity* papelerera *bin* 22,5 l
dispensador *dispenser* 700 usos *uses*

12020.ADO.S

Kit para modelo 12020.S instalación adosada
Installation kit for 12020.S surface mounted installation



12020.PS

Mueble empotrado con dispensador papel toalla y papelerera. Puerta frontal de una sola pieza

Flush mounted unit with towel paper dispenser and bin. Frontal door in one piece

Dimensiones *Dimensions*

1400 x 350 x 110 mm

Capacidad *Capacity* papelerera *bin* 17 l
dispensador *dispenser* 700 usos *uses*

12021.ADO.S

Kit para modelo 12021.S instalación adosada
Installation kit for 12021.S surface mounted installation



12021.S

Mueble empotrado con dispensador de papel toalla y papelerera de gran capacidad

Flush mounted unit with towel paper dispenser and high capacity bin

Dimensiones *Dimensions*

1371 x 438 x 180 mm

Capacidad *Capacity* papelerera *bin* 45 l
dispensador *dispenser* 700 usos *uses*

12021.ADO.S

Kit para modelo 12021.S instalación adosada
Installation kit for 12021.S surface mounted installation



12047.S

Mueble empotrado con dispensador de papel toalla y papelerera.

Flush mounted unit with towel paper dispenser and bin.

Dimensiones *Dimensions*

660 x 362 x 108 mm

Capacidad *Capacity* papelerera *bin* 7,5 l
dispensador *dispenser* 350 usos *uses*

12047.ADO.S

Kit para modelo 12047.S instalación adosada
Installation kit for 12047.S surface mounted installation



12047.PS

Mueble empotrado con dispensador de papel toalla y papelerera. Puerta frontal de una sola pieza

Flush mounted unit with towel paper dispenser and bin. Frontal door in one piece

Dimensiones *Dimensions*

700 x 350 x 115 mm

Capacidad *Capacity* papelerera *bin* 6 l
dispensador *dispenser* 350 usos *uses*

12047.ADO.PS

Kit para modelo 12047.PS instalación adosada
Installation kit for 12047.PS surface mounted installation

MUEBLES COMPACTOS

SOAP DISPENSERS

Mueble empotrado *Flush mounted unit*
Material acero inoxidable AISI 304 *Material AISI 304 stainless steel*
Acabado SATINADO (.S) *SATIN finished (.S)*



12001.S

Papelera con puerta abatible de cierre automático
Bin with automatic folding door
Dimensiones *Dimensions*
432 x 330 x 115 mm
Capacidad *Capacity* 5,5 l



12031.S

Portarrollos doble de papel higiénico, papelera con puerta abatible de cierre automático y dispensador de aros higiénicos
Double toilet paper dispenser, bin with automatic folding door and toilet seat cover dispenser.
Dimensiones *Dimensions*
832 x 438 x 108 mm
Capacidad *Capacity* papelera bin 7,5 l
dispensador *dispenser* 500 usos *uses*



12035.S

Portarrollos doble de papel higiénico y papelera con puerta abatible de cierre automático
Double toilet paper dispenser and bin with automatic folding door
Dimensiones *Dimensions*
508 x 438 x 108 mm
Capacidad *Capacity* papelera bin 7,5 l



12010.S

Dispensador de papel toalla y dosificador de jabón líquido.
Espejo en puerta frontal.
Towel paper dispenser and mirror frontal door.
Dimensiones *Dimensions*
762 x 438 x 108 mm
Capacidad *Capacity* dispensador *dispenser* 700 usos *uses*
dosificador jabón *soap dispenser* 3 l

12008.P.S

Dispensador de papel toalla
Towel paper dispenser
Dimensiones *Dimensions*
450 x 350 x 110 mm
Capacidad *Capacity*
350 usos *uses*



12029.S

Dispensador de aros higiénicos
Toilet seat cover dispenser
Dimensiones *Dimensions*
324 x 438 x 67 mm
Capacidad *Capacity*
250 usos *uses*



12041.S

Dispensador de papel toalla y puerta abatible a papelera (no incluye papelera)
Towel paper dispenser and waste door (bin not included)
Dimensiones *Dimensions*
361 x 323 x 292 mm
Capacidad *Capacity*
350 usos *uses*

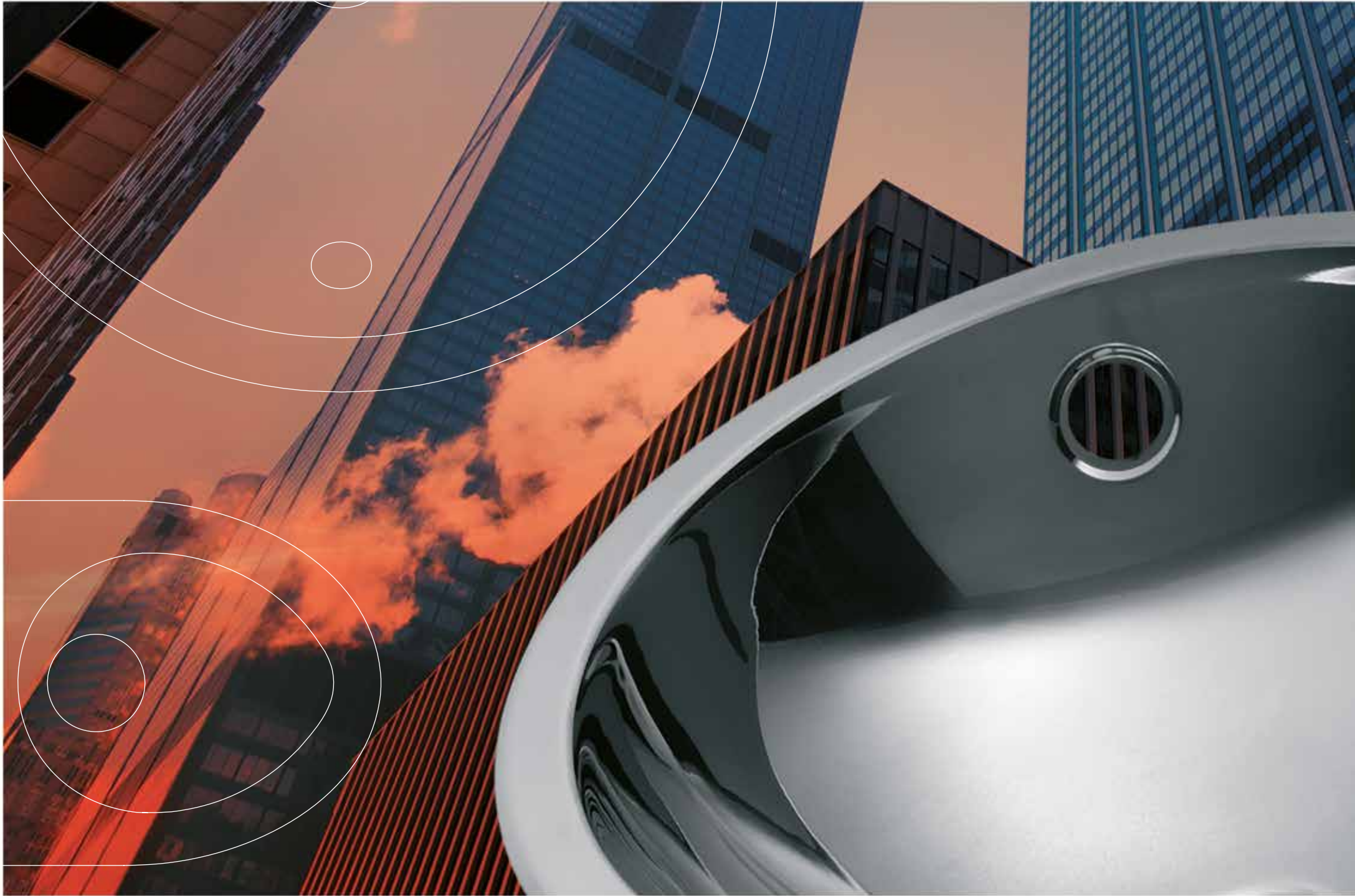



Sanitarios

INOX

Stainless steel sanitary ware

LAVAMANOS ENCASTRADOS

BUILT-IN WASH BASIN

Material acero inoxidable AISI 304 *Material AISI 304 stainless steel*
Acabados SATINADO (.S), BRILLO (.B) *Finishes SATIN (.S), POLISH (.B)*



Ala curva. Instalación sobre encimera
Curved flap. Installation on countertop

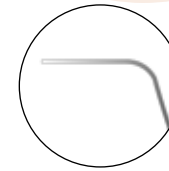

Ala plana. Instalación bajo encimera o soldada en superficies de acero inoxidable
Flat flap. Installation under countertop or welded to a stainless steel surface



13028.S 13028.B

Lavamanos sin orificio rebosadero
Washbasin without overflow
Dimensiones *Dimensions*
Ø int. 260 mm,
Ø ext. 305 mm,
Alto *Height* 110 mm

13028.RS 13028.RB

Lavamanos con orificio rebosadero
Washbasin with overflow
Dimensiones *Dimensions*
Ø int. 260 mm,
Ø ext. 305 mm,
Alto *Height* 110 mm

13029.S 13029.B

Lavamanos sin orificio rebosadero
Washbasin without overflow
Dimensiones *Dimensions*
Ø int. 310 mm,
Ø ext. 355 mm,
Alto *Height* 133 mm

13028.S.PLANA 13028.B.PLANA

Lavamanos sin orificio rebosadero
Washbasin without overflow
Dimensiones *Dimensions*
Ø int. 260 mm,
Ø ext. 305 mm,
Alto *Height* 110 mm

13028.RS.PLANA 13028.RB.PLANA

Lavamanos con orificio rebosadero
Washbasin with overflow
Dimensiones *Dimensions*
Ø int. 260 mm,
Ø ext. 305 mm,
Alto *Height* 110 mm

13029.S.PLANA 13029.B.PLANA

Lavamanos sin orificio rebosadero
Washbasin without overflow
Dimensiones *Dimensions*
Ø int. 310 mm,
Ø ext. 355 mm,
Alto *Height* 133 mm

13029.RS 13029.RB

Lavamanos con orificio rebosadero
Washbasin with overflow
Dimensiones *Dimensions*
Ø int. 310 mm,
Ø ext. 355 mm,
Alto *Height* 133 mm

13030.S 13030.B

Lavamanos sin orificio rebosadero
Washbasin without overflow
Dimensiones *Dimensions*
Ø int. 355 mm,
Ø ext. 405 mm,
Alto *Height* 152 mm

13030.RS 13030.RB

Lavamanos con orificio rebosadero
Washbasin with overflow
Dimensiones *Dimensions*
Ø int. 355 mm,
Ø ext. 405 mm,
Alto *Height* 152 mm

13029.RS.PLANA 13029.RB.PLANA

Lavamanos con orificio rebosadero
Washbasin with overflow
Dimensiones *Dimensions*
Ø int. 310 mm,
Ø ext. 355 mm,
Alto *Height* 133 mm

13030.S.PLANA 13030.B.PLANA

Lavamanos sin orificio rebosadero
Washbasin without overflow
Dimensiones *Dimensions*
Ø int. 355 mm,
Ø ext. 405 mm,
Alto *Height* 152 mm

13030.RS.PLANA 13030.RB.PLANA

Lavamanos con orificio rebosadero
Washbasin with overflow
Dimensiones *Dimensions*
Ø int. 355 mm,
Ø ext. 405 mm,
Alto *Height* 152 mm

Material acero inoxidable AISI 304 *Material AISI 304 stainless steel*
Acabados SATINADO (.S), BRILLO (.B) *Finishes SATIN (.S), POLISH (.B)*

SANITARIOS INOX

STAINLESS STEEL SANITARY WARE



13001.B 13001.S

Urinario para sistemas de descarga en superficie
Urinal suitable for surface mounted flush system
Dimensiones *Dimensions*
762 x 366 x 383 mm

13002.B 13002.S

Urinario para sistemas de descarga encastrados
Urinal suitable for built-in flush system
Dimensiones *Dimensions*
696 x 366 x 336 mm



13004.B 13004.S

Urinario para sistemas de descarga encastrados
Urinal suitable for built in flush system
Dimensiones *Dimensions*
600 x 360 x 395 mm



13007.B

Separador de urinarios chapa lisa
Plane plate urinal divider
Dimensiones *Dimensions*
680 x 50 x 350 mm



13008.S

Separador de urinarios chapa perforada
Perforated plate urinal divider
Dimensiones *Dimensions*
720 x 50 x 285 mm

HI-SET

www.hi-set.com



SANITARIOS INOX

STAINLESS STEEL SANITARY WARE

Material acero inoxidable AISI 304 / Material AISI 304 stainless steel
Acabados SATINADO (.S), BRILLO (.B) / Finishes SATIN (.S), POLISH (.B)



13012.B 13012.S

Inodoro a suelo, salida horizontal
Floor settled toilet, horizontal outlet
Dimensiones / Dimensions
390 x 355 x 540 mm



13013.B 13013.S

Inodoro a suelo, salida horizontal. Opcional salida vertical
Floor settled toilet, horizontal outlet. Optional vertical outlet
Dimensiones / Dimensions
390 x 355 x 640 mm



13018.B 13018.S

Inodoro suspendido. Salida horizontal
Wall-hung toilet, horizontal outlet
Dimensiones / Dimensions
380 x 355 x 550 mm

5000AR

Asiento inodoro con tapa color blanco
Toilet seat with cover white color
Material madera prensada
Material pressed wood



5000AR047

Asiento inodoro con tapa color negro
Toilet seat with cover black color
Material madera prensada
Material pressed wood



7200AR

Asiento inodoro con tapa color blanco
Toilet seat with cover white color
Material Tecnoplast
Material Tecnoplast



4403CLT

Asiento inodoro con tapa color blanco.
Bisagras cromadas, sistema StaTite y cierre lento
*Toilet seat with cover white color. Chromed hinges,
Sta-Tite system and soft close*
Material madera prensada
Material pressed wood

Material Acero inoxidable AISI 304 recubierto de Teflón®
Material Teflon® coated AISI 304 Stainless steel

TEFLON



13036.C.TE

Lavamanos mural cerrado. Con tapa de registro inferior.
Closed washbasin. With lower inspection hatch
Dimensiones *Dimensions*
270 x 360 x 360 mm



13004.TE

Urinario para sistemas de descarga encastrados
Urinal suitable for built-in flush systems
Dimensiones *Dimensions*
600 x 360 x 395 mm



13018.TE

Inodoro suspendido salida horizontal
Wall-hung toilet, horizontal outlet
Dimensiones *Dimensions*
380 x 355 x 550 mm

www.hi-set.com



PROPIEDADES RECUBRIMIENTO TEFLÓN®

Antiadherencia:

Muy pocas sustancias sólidas se quedan pegadas de forma permanente a los recubrimientos de Teflón®.

Si bien algunos materiales viscosos pueden adherirse muy ligeramente, la mayoría de las sustancias se despegarán con facilidad.

No humectante:

Dado que las superficies recubiertas con Teflón® son a la vez oleóforas e hidróforas, no es fácil que se humedezcan.

Se limpiarán más fácilmente que otras y en muchos casos son autolimpiantes.

Resistencia química:

Normalmente el Teflón® no resulta afectado por los agentes químicos más usuales en la industria.

TEFLON® COATING PROPERTIES

Non-stick :

Very few solid substances remain permanently attached to Teflon® coating.

While some viscous materials can remain temporarily attached, most of the substances will be removed easily.

Non-wetting :

Since surfaces coated with Teflon® are both oleophobic and hydrophobic, they are not easy to get wet.

The Teflon® coated surfaces are cleaned easier than others and in many cases they are self-cleaning.

Chemical resistance:

Teflon® is normally unaffected by the usual chemical industry agents.

CAMBIAPAÑALES

Baby changing units



CAMBIAPAÑALES

BABY CHANGING UNITS

Material Acero inoxidable AISI 304 / Material AISI 304 Stainless steel
Acabado SATINADO (.S) / SATIN finished (.S)



3604



3602



3612

Zonas comunes

PAPELERAS

Common areas Bins



Material .S y .B: acero inoxidable, .W: acero
Acabados SATINADO (.S), BRILLO (.B), BLANCO (.W) Finishes SATIN (.S), POLISH (.B), WHITE (.W)

PAPELERAS

BINS



14077.S 14077.B 14077.W

Papelera mural sin tapa

Wall mounted wastepaper bin without cover

Dimensiones Dimensions

435 x 355 x 155 mm

Capacidad Capacity

23 l

14078.S 14078.B 14078.W

Papelera mural con tapa

Wall mounted wastepaper bin with cover

Dimensiones Dimensions

495 x 365 x 160 mm

Capacidad Capacity

23 l

HI-SET

PAPELERAS

BINS



14098.2

Papelera mural sin tapa

Wall mounted wastepaper bin

Acero pintado (ver carta de color)

Painted steel (see color range)

Dimensiones Dimensions 285 x 325 x 125 mm

Capacidad Capacity 11 litros litres

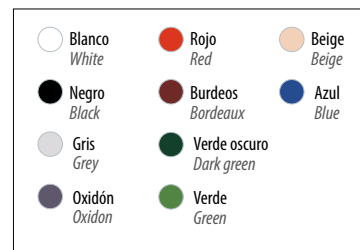

09004.S

Cubeta higiénica mural con tapa

Wall mounted wastepaper bin with cover

Dimensiones Dimensions

272 x 228 x 98 mm

Capacidad Capacity

5,7 litros litres



14082.2

Papelera con asas Wastepaper bin

Material Metal pintado (ver carta de color)

Material Painted steel (see color range)

Dimensiones Dimensions

320 mm alto, Ø 215 mm

Capacidad Capacity 12 litros litres

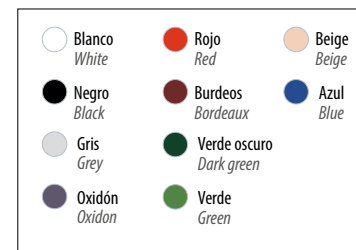

14096.2.S

Papelera sin tapa Wastepaper bin without lid

Material Acero inoxidable AISI 304

Material AISI 304 Stainless steel

Dimensiones Dimensions

315 mm Ø 215 mm

Capacidad Capacity

12 litros litres

Material Acero inoxidable AISI 304 *Material AISI 304 Stainless steel*
 Acabados SATINADO (.S), BRILLO (.B), BLANCO, (.W), (.N) NEGRO,
 Finishes SATIN (.S), POLISH (.B), WHITE (.W)

PAPELERAS

BINS



14075.40.B

Papelera gran capacidad
High capacity bin
 Dimensiones *Dimensions*
 660 x 330 x 280 mm
 Capacidad *Capacity*
 40 litros *litres*



14075.65.B

Papelera gran capacidad
High capacity bin
 Dimensiones *Dimensions*
 840 x 360 x 280 mm
 Capacidad *Capacity*
 65 litros *litres*



14075.80.B

Papelera gran capacidad
High capacity bin
 Dimensiones *Dimensions*
 1050 x 370 x 290 mm
 Capacidad *Capacity*
 80 litros *litres*



14114.B

Papelera push-open
Push-open bin
 Dimensiones *Dimensions*
 400 mm, Ø 200 mm
 Capacidad *Capacity*
 10 litros *litres*



14116.B

Papelera push-open
Push-open bin
 Dimensiones *Dimensions*
 650 mm, Ø 300 mm
 Capacidad *Capacity*
 35 litros *litres*



14117.B

Papelera push-open
Push-open bin
 Dimensiones *Dimensions*
 750 mm, Ø 360 mm
 Capacidad *Capacity*
 71 litros *litres*

EJ00268501 EJ00268502 EJ00268503

Cenicero para exterior Incluye cubo interior de acero
Steel inner bucket included Outdoor ashtray
 Material Polietileno *Polyethylene*
 Color EJ00268501 - gris / grey
 EJ00268502 - marrón / brown
 EJ00268503 - negro / black
 Dimensiones *Dimensions* Ø 305, alto *height* 965 mm



EJ0026612G EJ0026655G

Papelera ignífuga *Fire retardant bin*
 Material acero pintado color gris
Grey color painted steel
 Capacidad *Capacity*
 EJ0026612G 45 l EJ0026655G 200 l
 Dimensiones *Dimensions*
 EJ0026612G - 533 mm, Ø 384 mm
 EJ0026655G - 902 mm, Ø 610 mm



PICTOGRAMAS

Signal pictographs



Material Acero inoxidable AISI 304 / Material AISI 304 Stainless steel
Autoadhesivos / Self-adhesive

PICTOGRAMAS

SIGNAL PICTOGRAPHS



16710.S



16711.S



16712.S

Dimensiones / Dimensions
125 x 125 mm



16720.S

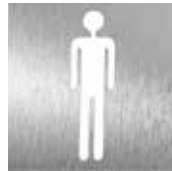

16721.S



16722.S



16723.S



16724.S



16725.S



16726.S



16727.S



16728.S



16729.S



16730.S



16731.S



16732.S



16733.S



16734.S

Dimensiones / Dimensions
120 x 120 mm



EL DERECHO DE TODAS LAS PERSONAS A ACCEDER A CUALQUIER ALOJAMIENTO NOS INVITA A OFRECER UNA DIFERENCIACIÓN DE NUESTRO MUNDO PARTICULAR QUE ES NUESTRO HOTEL.

LA EXPERIENCIA DEL VISITANTE DEBE SUPERAR CON CRECES, EN CONFORTABILIDAD, EL ESTAR EN CASA, SEA CUAL SEA SU CONDICIÓN. LA LEY NOS EXIGE UN MÍNIMO DE ACCESIBILIDAD EN NUESTRAS INSTALACIONES, LA EXPERIENCIA Y EMPATÍA DE **HI-SET** LES OFRECE LAS SOLUCIONES QUE, EN NUESTRO SECTOR, CUBREN LAS NECESIDADES DE TODO EL VISITANTE: UNA ESTANCIA 100% ACCESIBLE.

THE RIGHT OF EVERYONE TO ACCESS ANY ACCOMMODATION INVITES US TO OFFER A DISTINCTION OF OUR PARTICULAR WORLD, THAT IS OUR HOTEL. THE GUEST'S EXPERIENCE SHOULD GREATLY EXCEED, IN COMFORT, HIS STAY AT HOME, WHATEVER BE HIS CONDITION. THE LAW CALLS FOR A MINIMUM OF ACCESSIBILITY IN OUR INSTALATIONS, NOFER'S EXPERIENCE AND EMPATHY OFFERS THE SOLUTIONS, THAT ESPECIALLY IN OUR INDUSTRY, MEET THE NEEDS OF EVERY GUEST: A 100 % REACHABLE STAY.

ENTREMOS...

LET'S WALK IN...





Technical aids

AYUDAS

técnicas



AYUDAS TÉCNICAS

TECHNICAL AIDS

Barras de apoyo rectas con dos puntos de fijación *Straight grab bars with two fixing points*
 Material Acero inoxidable AISI 304 (acabado .S, .B y .W). Acero (acabado .F). *Material AISI 304 Stainless steel (.S, .B and .W finish). Steel (.F finish)*
 Acabados SATINADO (.S), BRILLO (.B), BLANCO (.W), BLANCO sin florón (.F) *Finishes SATIN (.S), POLISH (.B), WHITE (.W), WHITE without flange cover (.F)*
 barra bar Ø 32 mm

Longitud *Length*

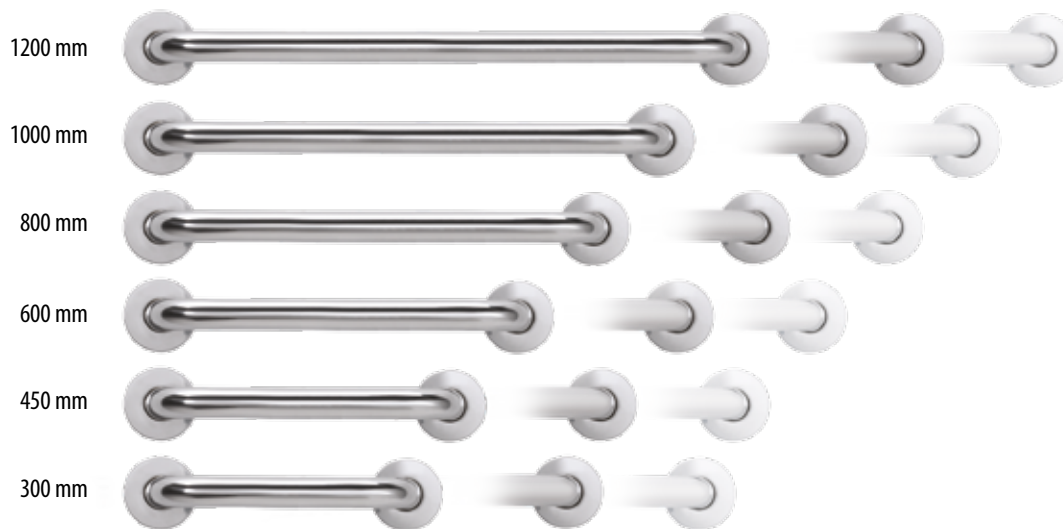

15054.120.S 15054.120.B 15054.120.W

Longitud *Length* 1200 mm

15054.100.S 15054.100.B 15054.100.W

Longitud *Length* 1000 mm

15054.80.S 15054.80.B 15054.80.W 15054.80.F

Longitud *Length* 800 mm

15054.60.S 15054.60.B 15054.60.W 15054.60.F

Longitud *Length* 600 mm

15054.45.S 15054.45.B 15054.45.W 15054.45.F

Longitud *Length* 450 mm

15054.30.S 15054.30.B 15054.30.W 15054.30.F

Longitud *Length* 300 mm



Barras de apoyo abatibles *Swing-up grab bars*

Material Acero inoxidable AISI 304 (acabado .S, .B y .W). Acero (acabado .F). Material AISI 304 Stainless steel (.S, .B and .W finish). Steel (.F finish)

Acabados SATINADO (.S), BRILLO (.B), BLANCO (.W), BLANCO (.F) Finishes SATIN (.S), POLISH (.B), WHITE (.W), WHITE (.F)

barra bar Ø 32 mm

AYUDAS TÉCNICAS

TECHNICAL AIDS

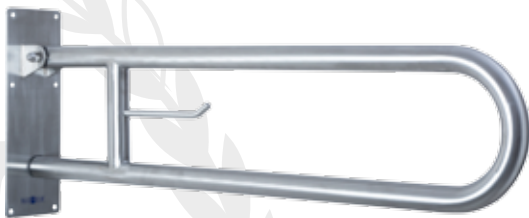

15051.80.S 15051.80.B
15051.80.W 15051.80.F

Con portarrollos
With toilet paper holder hook
Longitud *Length* 800 mm

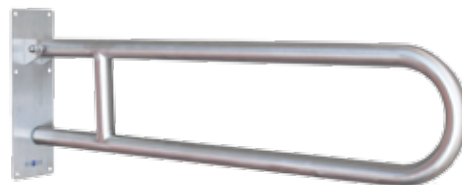

15051.SP.80.S 15051.SP.80.B
15051.SP.80.W

Sin portarrollos *Without toilet paper holder hook*
Longitud *Length* 800 mm

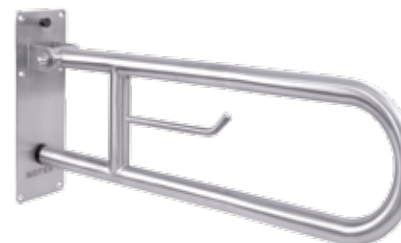

15051.60.S 15051.60.B
15051.60.W 15051.60.F

Con portarrollos *With toilet paper holder hook*
Longitud *Length* 600 mm



15053.S 15053.B 15053.W

Kit fijaciones para hotel *Fixation kit for hotel*
Adequado para 15051.80, 15051.60,
15051.85, 15206

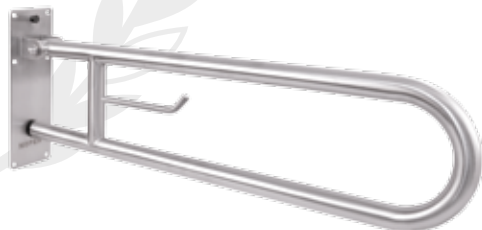

15051.85.S 15051.85.B 15051.85.W

Con portarrollos *With toilet paper holder hook*
Longitud *Length* 850 mm



15064.S 15064.B 15064.W

Con anclaje a suelo y portarrollos
With anchor to floor and toilet paper holder
Dimensiones *Dimensions*
820 x 800 x 200mm
(Dimensiones totales *Total dimensions*)



15206.S 15206.B 15206.W

Con pata de soporte a suelo y portarrollos
With support to floor and toilet paper holder hook
Dimensiones *Dimensions*
Longitud *Length* 800 mm, altura *Height* 750 mm



15062.S 15062.B 15062.W

Con pata de soporte a suelo y portarrollos
With support to floor and toilet paper holder hook
Dimensiones *Dimensions*
750 x 100 x 780 mm

AYUDAS TÉCNICAS

TECHNICAL AIDS

Barras de apoyo Grab bars
Material Acero inoxidable AISI 304 (acabado .S, .B y .W) Material AISI 304 Stainless steel (.S, .B and .W finish)
Acabados SATINADO (.S), BRILLO (.B), BLANCO (.W) Finishes SATIN (.S), POLISH (.B), WHITE (.W)
barra bar Ø 32 mm

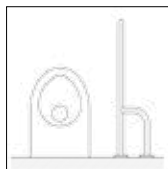

15047.S 15047.B 15047.W

Triple soporte pared Three wall support
Dimensiones Dimensions
600 mm

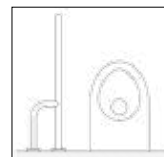

15048.S 15048.B 15048.W

Triple soporte pared Three wall support
Dimensiones Dimensions
600 mm



15203.S 15203.B 15203.W

Soporte pared-suelo Wall-floor support
Dimensiones Dimensions
700 x 700 mm

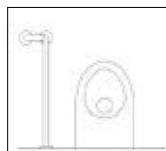
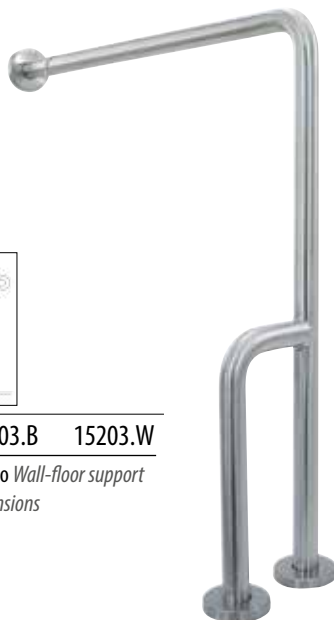

15204.S 15204.B 15204.W

Soporte pared-suelo Wall-floor support
Dimensiones Dimensions
700 x 700 mm



15198.S 15198.B 15198.W

Soporte pared-suelo Wall-floor support
Dimensiones Dimensions
700 x 700 mm

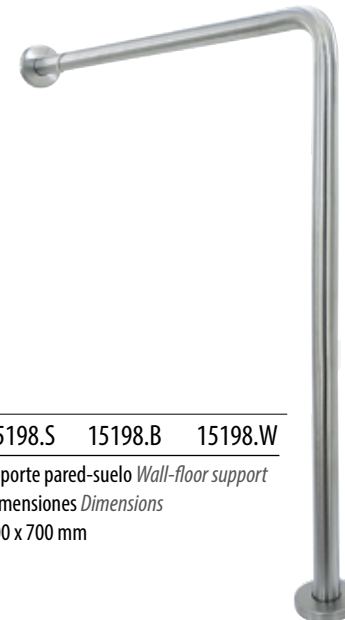

AYUDAS TÉCNICAS

TECHNICAL AIDS

Barras de apoyo angulares *Angled grab bars*
 Material Acero inoxidable AISI 304 (acabado .S. .B y .W) *Material AISI 304 Stainless steel (.S. .B and .W finish)*
 Acabados SATINADO (.S), BRILLO (.B), BLANCO (.W) *Finishes SATIN (.S), POLISH (.B), WHITE (.W)*
 Barra *bar* Ø 32 mm

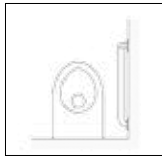

15158.S 15158.B 15158.W

Dimensiones *Dimensions*
 Brazo vertical *Vertical arm*: 700 mm.
 Brazo horizontal *Horizontal arm*: 400 mm



15159.S 15159.B 15159.W

Dimensiones *Dimensions*
 Brazo vertical *Vertical arm*: 700 mm.
 Brazo horizontal *Horizontal arm*: 400 mm



15060.S 15060.B 15060.W

Posición reversible *Reversible position*
 Dimensiones *Dimensions*
 600 x 600 mm



15068.S 15068.B 15068.W

Ángulo de 135° *135° angle*
 Dimensiones *Dimensions*
 Longitud brazo *Arm length*: 300 mm.



15069.S 15069.B 15069.W

Ángulo de 60° *60° angle*
 Dimensiones *Dimensions*
 Longitud brazo *Arm length*: 400 mm.



15052.S 15052.B 15052.W

Ángulo de 90° *90° angle*
 Dimensiones *Dimensions*
 700 x 700 mm.

AYUDAS TÉCNICAS

TECHNICAL AIDS



15049.S 15049.B 15049.W

Barra doble ángulo *Double angle bar*

Dimensiones *Dimensions*

Brazo horizontal *Horizontal arm* 425 x 580 mm

Brazo vertical *Vertical arm* 730 mm

Barra bar Ø 32 mm



15209.B

Soporte para rociador de ducha

Shower head support

Material ABS Cromado

Material Chromed ABS

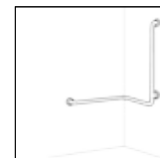

15050.S 15050.B 15050.W

Barra doble ángulo *Double angle bar*

Dimensiones *Dimensions*

Brazo horizontal *Horizontal arm* 425 x 580 mm

Brazo vertical *Vertical arm* 730 mm

Barra bar Ø 32 mm



08024.S 08024.B 08024.W

Material Acero inoxidable AISI 304 (acabado .S y .B). Acero (.W)

Material AISI 304 Stainless steel (.S, .B and .W finish). Steel (.W)

Acabados SATINADO (.S), BRILLO (.B), BLANCO (.W)

Finishes SATIN (.S), POLISH (.B), WHITE (.W)

Dimensiones *Dimensions*

800 x 600 x 75 mm

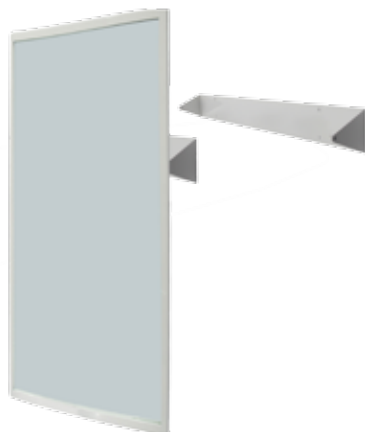

08023.S 08023.B 08023.W

Material Acero inoxidable AISI 304 (acabado .S y .B). Acero (.W)

Material AISI 304 Stainless steel (.S, .B and .W finish). Steel (.W)

Acabados SATINADO (.S), BRILLO (.B), BLANCO (.W)

Finishes SATIN (.S), POLISH (.B), WHITE (.W)

Dimensiones *Dimensions*

700 x 500 x 75 mm

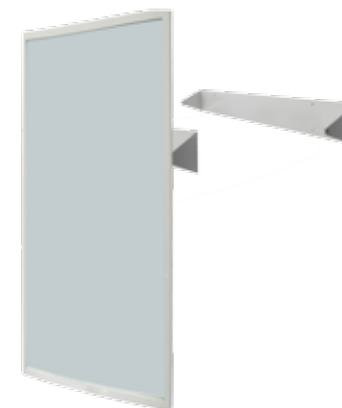

Barras de apoyo rectas *Straight grab bars*
Material Aluminio con recubrimiento Nylon anti-bacterias. Fijaciones de acero inoxidable AISI 304 con florones Nylon.
Material Aluminium with antibacterial Nylon coating. AISI 304 stainless steel fixing points with Nylon flange covers.
Acabado BLANCO *WHITE finished* Barra bar Ø 34 mm

AYUDAS TÉCNICAS

TECHNICAL AIDS

Longitud *Length*

40 mm



50 mm



60 mm



73 mm



120 mm



15054.40.NBA

Dimensiones *Dimensions*
40 mm

15054.50.NBA

Dimensiones *Dimensions*
50 mm

15054.60.NBA

Dimensiones *Dimensions*
60 mm

15054.73.NBA

Dimensiones *Dimensions*
73 mm

15054.120.NBA

Dimensiones *Dimensions*
120 mm

AYUDAS TÉCNICAS

TECHNICAL AIDS

Acabado BLANCO *WHITE finished*
Barra bar Ø 34 mm

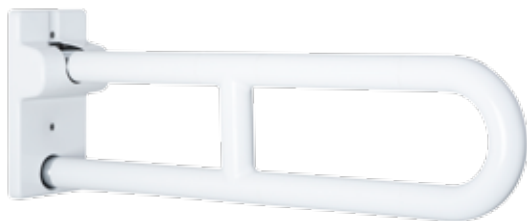

15051.60.NBA

Barra de apoyo abatible de acero recubierto Nylon anti-bacterias
Nylon coated steel swing-up grab bar
Dimensiones *Dimensions* 600 mm

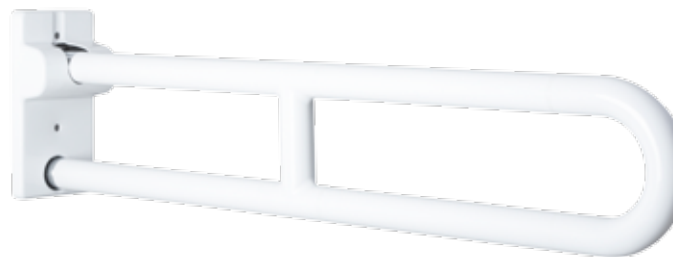

15051.80.NBA

Barra de apoyo abatible de acero recubierto Nylon anti-bacterias
Nylon coated steel swing-up grab bar
Dimensiones *Dimensions* 800 mm



15051.NPR

Portarrollos Nylon adaptable a barra abatible
Nylon toilet paper holder for swing-up grab bar



15158.NBA

Barra angular de aluminio recubierto Nylon anti-bacterias
Nylon coated aluminium angled bar angular
Dimensiones *Dimensions* 700 x 400 mm

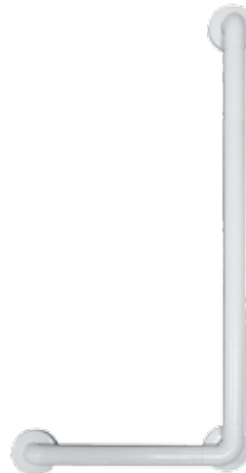

15159.NBA

Barra angular de aluminio recubierto Nylon anti-bacterias
Barra angular de aluminio recubierto Nylon anti-bacterias
Dimensiones *Dimensions* 700 x 400 mm



15060.NBA

Barra angular de aluminio recubierto Nylon anti-bacterias
Barra angular de aluminio recubierto Nylon anti-bacterias
Dimensiones *Dimensions* 600 x 600 mm

Barras de apoyo angulares *Angled grab bars*

Material Aluminio con recubrimiento Nylon anti-bacterias. Fijaciones de acero inoxidable AISI 304 con florones Nylon.

Material Aluminium with antibacterial Nylon coating. AISI 304 stainless steel fixing points with Nylon flange covers.

Acabado BLANCO *WHITE finished* Barra bar Ø 34 mm

AYUDAS TÉCNICAS

TECHNICAL AIDS



15158.120.70.NBA

15159.120.70.NBA

Dimensiones *Dimensions*

1200 x 700 mm



15052.NBA

Dimensiones *Dimensions*

700 x 700 mm



15209

Soporte Nylon para rociador de ducha.

Adecuado para barras Ø 34mm

Nylon support for shower head.

Suitable for Ø 34mm bars

AYUDAS TÉCNICAS

TECHNICAL AIDS

106



15049.NBA

Barra doble angulo de aluminio recubierto Nylon anti-bacterias
Aluminium with antibacterial Nylon coating double angle bar
Brazo horizontal *Horizontal arm* 700 x 700 mm
Brazo vertical *Vertical arm* 800 mm



15206.NBA

Barra de apoyo abatible de acero recubierto Nylon anti-bacterias con apoyo a suelo
Nylon coated steel swing-up grab bar with floor support
Dimensiones *Dimensions* 800 mm



15064.NBA

Barra de apoyo abatible de acero recubierto Nylon anti-bacterias con anclaje a suelo
Nylon coated steel swing-up grab bar with floor anchoring
Dimensiones *Dimensions* 793 x 150 x 860 mm
Altura de apoyo *Support height* 750 mm

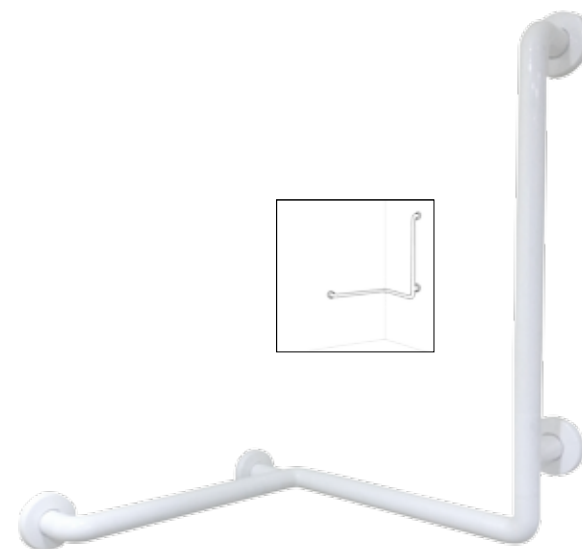

15050.NBA

Barra doble angulo de aluminio recubierto Nylon anti-bacterias
Aluminium with antibacterial Nylon coating double angle bar
Brazo horizontal *Horizontal arm* 700 x 700 mm
Brazo vertical *Vertical arm* 800 mm

Barras apoyo de aluminio recubierto Nylon anti-bacterias
Aluminium with antibacterial Nylon coating grab bar
Barra bar Ø 34 mm

AYUDAS TÉCNICAS

TECHNICAL AIDS



15203.NBA

Barra de apoyo pared-suelo con doble soporte a suelo. Posición reversible
Angled wall-to-floor bar with two floor support. Reversible position
Dimensiones Dimensions
733 x 102 x 733 mm



15047.60.NBA

Barra de apoyo con tres puntos de fijación a pared. Posición reversible
Grab bar with three wall fixing points. Reversible position
Longitud Length 600 mm



15047.80.NBA

Barra de apoyo con tres puntos de fijación a pared. Posición reversible
Grab bar with three wall fixing points. Reversible position
Longitud Length 800 mm



15070.NBA

Asidero Handle
Longitud Length 120 mm





Seats

ASIENTOS

ASIENTOS DUCHA

SHOWER SEATS

Material Polipropileno anti-bacterias Fijaciones de acero inoxidable AISI 304
Material Antibacterial polypropylene Stainless steel wall fixations
Acabado BLANCO WHITE finished



15042.NBA

Asiento plegable *Folding seat*
Dimensiones *Dimensions*
80 x 420 x 420 mm



15042.FIX.NBA

Asiento plegable con respaldo
Folding seat with backrest
Dimensiones *Dimensions*
446 x 420 x 420 mm



15042.PAT.NBA

Asiento plegable con respaldo y dos patas regulables
Folding seat with backrest and two adjustable legs
Dimensiones *Dimensions*
740 - 835 x 420 x 420 mm



15042.MOV.NBA

Asiento amovible y plegable con respaldo
Removable folding seat with backrest
Dimensiones *Dimensions*
480 x 420 x 480 mm

Material Acero inoxidable AISI 304 *Material AISI 304 Stainless steel*
Acabado *Finish SATINADO .S (S) BRILLO POLISHED (.B) BLANCO WHITE (.W)*

ASIENTOS DUCHA

SHOWER SEATS

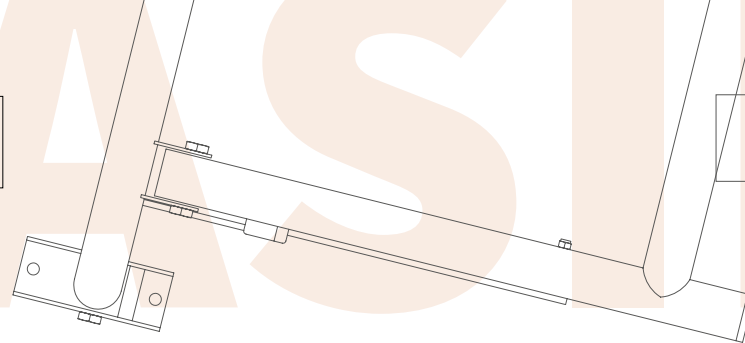

15045.S 15045.B 15045.W

Con doble apoyo a suelo
With two floor support
Dimensiones *Dimensions*
440 x 450 x 410 mm



15046.S 15046.B 15046.W

Con doble apoyo a pared
With two wall support
Dimensiones *Dimensions*
346 x 450 x 410 mm



15065.S

Con asiento de tabla fenólica y soporte en pared
Phenolic seat with wall support
Dimensiones *Dimensions*
388 x 456 x 420 mm



15066.S

Con asiento acolchado y soporte en pared
Padded seat with wall support
Dimensiones *Dimensions*
425 x 450 x 420 mm

ASIENTOS DUCHA Y BAÑERA

SHOWER AND BATH TUBE SEATS

Material Acero inoxidable AISI 304 *Material AISI 304 Stainless steel*
 Acabado *Finish SATINADO SATIN (.S) BRILLO POLISHED (.B) BLANCO WHITE (.W)*

15041.S

Dimensiones *Dimensions*
 100 x 434 x 454 mm



15067.2

Dimensiones *Dimensions*
 100 x 325 x 325 mm
 Material Aluminio y ABS
Material Aluminium and ABS



15042.MOV.B 15042.MOV.S 15042.MOV.W

Asiento amovible para ducha (no plegable)
Removable seat for shower. (not folding)
 Material Acero inoxidable AISI 304
Material AISI 304 Stainless steel
 Dimensiones *Dimensions*
 498 x 450 x 416 mm



15043.N

Asiento para bañera *Seat for bath tube*
 Material Aluminio recubierto nylon
Material Aluminium-nylon coated
 Dimensiones *Dimensions*
 260 x 700 x 480 mm



15044.N

Taburete *Bathstool*
 Material Aluminio recubierto nylon
Material Aluminium-nylon coated
 Dimensiones *Dimensions*
 250 x 355 x 320 mm

15044.N

Taburete *Bathstool*
 Material Aluminio recubierto nylon
Material Aluminium-nylon coated
 Dimensiones *Dimensions*
 420 x 550 x 320 mm

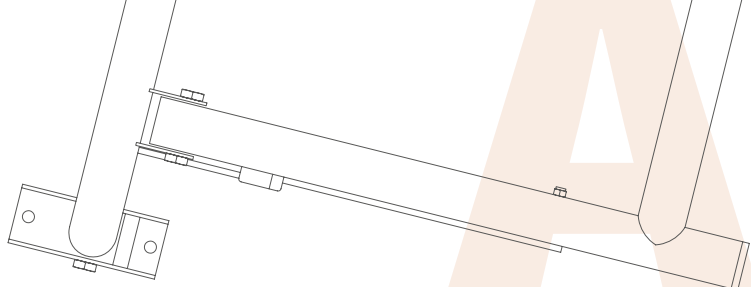

ASIENOS CON ALZA

TOILET SEAT RISERS



15032

Asiento ergonómico sin tapa.
Suplemento elevador 100 mm
*Ergonomic seat without lid.
It raises 100 mm*
Material Material
Polipropileno Polypropylene



15033

Asiento ergonómico con tapa.
Suplemento elevador 100 mm
*Ergonomic seat with lid.
It raises 100 mm*
Material Material
Polipropileno Polypropylene



15034

Asiento ergonómico sin tapa y con dos asideros
Suplemento elevador 100 mm
*Ergonomic seat without lid and with two handles
It raises 100 mm*
Material Material
Polipropileno Polypropylene

ASIENTOS CON ALZA

TOILET SEAT RISERS



15039

Asiento ergonómico con tapa.

Suplemento elevador 100 mm

Ergonomic seat with lid. It raises 100 mm

Material *Material*

Asiento Duraplast. Tapa Poliester

Duraplast seat. Polyester lid



K10

Asiento ergonómico con abertura higiénica

frontal y tapa. Suplemento elevador 100 mm

Ergonomic seat with hygienic frontal opening

and lid. It raises 100 mm

Material *Material*

Durolux *Durolux*

ASIENOS WC

TOILET SEATS

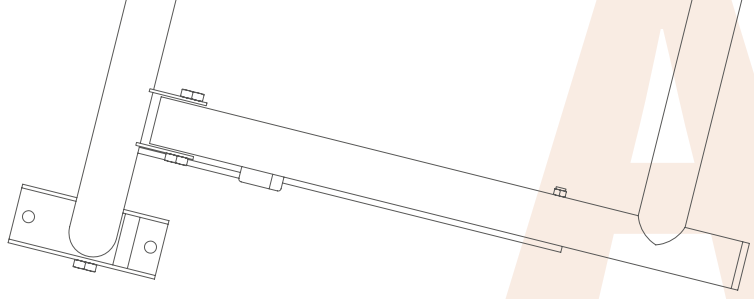

16SS

Asiento WC con abertura higiénica frontal. Adaptable a la mayoría de inodoros.

Toilet seat with hygienic frontal opening. It fits on most of the toilets

Material *Material*
Durolux *Durolux*



4230CP

Asiento WC para niños y adultos. Adaptable a la mayoría de inodoros.

Toilet seat for children and adults. It fits on most of the toilets

Material *Material*
Durolux *Durolux*



2040AR

Asiento para inodoro con abertura higiénica y tapa. Adaptación universal

Hoop seat with hygienic opening and cover. Universal adaptation

Material *Material*
Durolux *Durolux*



EMERGENCIA

Emergency



EMERGENCIA

EMERGENCY



ES00SE597

Unidad portátil presurizada de ACERO INOXIDABLE con lavajos flexible de un chorro aireado.

STAINLESS STEEL portable pressurized unit with one aerated jet flexible eyewash.

Capacidad Capacity
20 l



FARC396

Lavaojos y lavacara de emergencia portátil de polietileno de alta densidad y funcionamiento por gravedad.

High density polyethylene portable eye and face wash, function by gravity.

Capacidad Capacity
34 l



ES00SE4300

Lavaojos y lavacara de emergencia portátil de polietileno de alta densidad y funcionamiento por gravedad.

High density polyethylene portable eye and face wash, function by gravity.

Capacidad Capacity
80 l

Material Cuerpo de acero cincado recubierto pintura epoxy (Ral 6029)
Material Epoxy painted zinc galvanized body (Ral 6029)



SC300 SC300SS

Lavaojos con chorros aireados con válvula de cierre manual y accionado mediante palanca lateral de empuje

Eyewash with aerated flow with manual closing valve and operated by lateral push lever

Instalación mural *Wall mounted installation*

SC300SS

Recogedor de Acero inoxidable

Stainless steel bowl

SC300

Recogedor de Polipropileno

Polypropylene bowl



SC320 SC320SS

Lavaojos con chorros aireados con válvula de cierre manual y accionado mediante palanca lateral de empuje

Eyewash with aerated flow with manual closing valve and operated by lateral push lever

Instalación pedestal a suelo *Floor pedestal installation*

SC320SS

Recogedor de Acero inoxidable

Stainless steel bowl

SC320

Recogedor de Polipropileno

Polypropylene bowl



SC700 SC700SS

Combinación de ducha de emergencia y lavaojos con chorros aireados. Operación manual mediante barra rígida de tiro con mango triangular en la ducha y palanca de empuje lateral en el lavaojos.

Emergency shower and aerated flow eyewash combination. Manual operated shower by pull rod triangular handle. Manual operated eyewash by lateral push lever.

Instalación pedestal a suelo *Floor pedestal installation*

SC320SS

Recogedor y rociador de Acero inoxidable

Stainless steel bowl and shower head

SC320

Recogedor y rociador de Polipropileno

Polypropylene bowl and shower head

EMERGENCIA

EMERGENCY

La norma ANSI Z358.1-1998, nos informa que las duchas y lavaojos de emergencia son necesarios para proporcionar los primeros auxilios, entre otros, a personas accidentadas por productos químicos o por líquidos peligrosos e irritantes. En las instalaciones hoteleras este tipo de productos son usados para el buen mantenimiento de piscinas, spas y otras zonas comunes. Un equipo de emergencia puede salvar vidas...

The regularion ANSI Z358.1-1998 informs us that eyewashers and emergency showers are needed to give first aids, among others, to persons injured by chemicals or hazardous and irritating liquids. Hotel facilities may use this kind of dangerous products, for example, for the good maintenances of pools, spa and similar areas. Equipping with an emergency unit can save lives...

NOER®

